

Other types of Movement

So far we seen Wh-movement, which moves certain types of (XP) constituents to the specifier of a CP.

Wh-movement is also called “A-bar movement”.

We will look at two more types of movement.

The first of these is a type of head-movement. That is, an X^0 moves, not an XP. Specifically a V^0 .

In effect, we have already seen this movement when we looked at matrix questions:

- 46a. What has he eaten?
- b. Why should she leave?
- c. Where can I go?
- d. Who must she interview?
- e. When is he leaving?

How do we get the word order in these sentences? In English (and other languages) matrix questions require a verb in C^0 . Never mind *why* they do. Just take it as a given that they do.

How does the verb get there?

Certain verbs are already in I^0 , among them auxiliaries *be* and *have*, the modals *can*, *could*, *may*, *might*, *should*, *must*.

For those, it is very easy to satisfy the requirement to have a verb in C^0 :

Head-movement!

When the verb cannot appear in I^0 , as with all the lexical verbs in English, we get *do*-insertion.

Is *do* inserted straight into C^0 to satisfy its need for a verb?

No! It carries tense and agreement. So it is first inserted in I^0 and then moves to C^0 .

46d.

Did you notice that again, movement is to a c-commanding position?

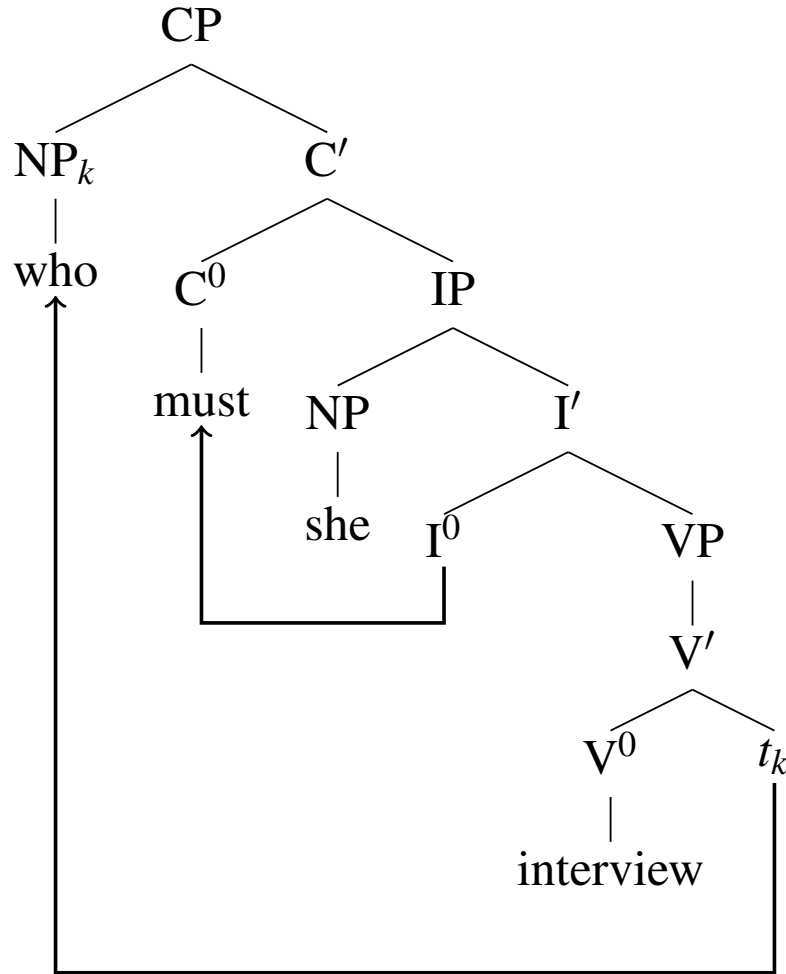

- I⁰-to-C⁰ movement causes “subject-verb inversion”. Do you see why it would be called that?

Here are some other environments with I⁰-to-C⁰ movement in English (in addition to Wh-questions):

Yes/no questions:

47. Must he leave?

“Negative-inversion”:

48. [Never before in my life] have I seen such a mess

49. [Only if you give me \$10K] will I give you my piano

48'. *[Never before in my life] I have seen such a mess

49'. *[Only if you give me \$10K] I will give you my piano

50a. [If you give me \$10K] I will give you my piano

b. *If you give me \$10K] will I give you my piano

- I⁰-to-C⁰ movement also causes a phenomenon called “Verb Second”. Can you see why it would be called that?

51. [Where] has she gone?

52. [Which of the books I gave her] has she read?

53. [Never before in my life] have I seen such a mess

54. [Only if you give me \$10K] will I give you my piano

V2: the verb comes directly after the first constituent and it doesn't matter how long the first constituent is:

55. [Which of the books that your uncle who studied at Stanford thinks were written by Tolstoy but were actually written by Dostoyevsky and were published by an obscure press] has she read?

- English used to be what is called a “generalized” V2 language. That is, it had V2 everywhere. Now it is a “residual” V2 language. That is, it has V2 in certain restricted environments, as we saw, but not everywhere:

56. Yesterday, John left

57. If it rains, she stays inside

However, there are plenty of languages that are generalized V2 today:

- The Germanic languages German, Dutch, Swedish and others
- The Kru language Vata (in Africa)
- The Indo-Aryan language Kashmiri (Indian subcontinent)
- The Arikem language Karitiana (Brazil)

Topicalization in a non-V2 L or

Topicalization in a non-V2 L

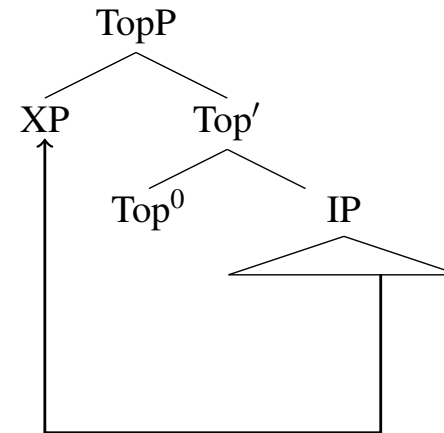
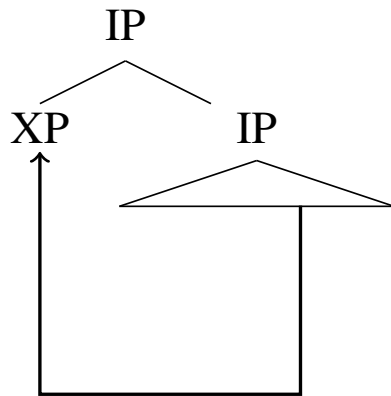

[Yesterday] she read a book

[If you give me \$10K] I will give you my piano

[Susan] I really like

Topicalization in a V2 Language

Exactly like wh-questions in English

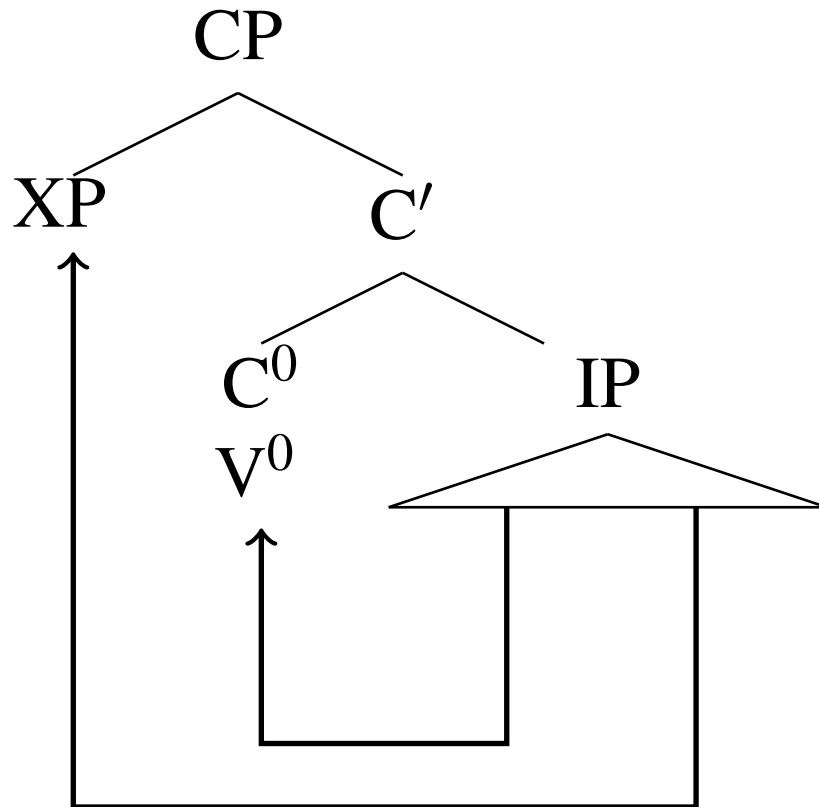

Here is some German. Notice how the verb comes immediately after the first constituent

58. [Gestern] ist der Hans weggefahren.
yesterday is the Hans left
“Yesterday Hans left”
59. [Weil er krank ist] ist er zuhause geblieben.
[because he sick is] is he at-home stayed
“Because he is sick, he stayed home”
60. [Wenn es regnet] bleibt Katharina zuhause
if it rains stays Katharina at-home
“If it rains, Katharina stays home”
61. [Den Hans] liebt die Maria
the Hans loves the Maria
“Hans, Maria loves”

- Now look at these:

62. die Katharina liebt den Hans
 the Katharina loves the Hans
 S V O

“Katharina loves Hans”

63. Ich glaube dass die Katharina den Hans liebt.
 I believe that the Katharina the Hans loves
 S O V

“I believe that Katharina loves Hans”

64. * die Katharina den Hans liebt
 the Katharina the Hans loves
 S O V

65. * Ich glaube dass die Katharina liebt den Hans .
 I believe that the Katharina loves the Hans
 S V O

- German is SOV.
- SVO is the result of V2!
- V2 is I⁰-to-C⁰ movement
- The presence of the complementizer blocks I⁰-to-C⁰ movement

- It's not a matter of matrix versus embedded clauses because matrix clauses with a complementizer can't have V2 and embedded clauses without a complementizer can:

66. Dass er mir so was antun kann!
that he to-me such something on-do can
"That he can do such a thing to me"

67. Ich glaube die Katharina liebt den Hans .
I believe the Katharina loves the Hans
"I believe that Katharina loves Hans"

- Imagine that you find SVO sentences in the language you are investigating.

Can you conclude that the language is V2?

No! It could be that this is a genuine SVO language.

In order to conclude that it is V2, the verb would have to be in 2nd place no matter what the first constituent is:

Adv V SO

O V S

- “Verb second” is just a descriptive term for a phenomenon.
- The result is produced by I^0 -to- C^0 movement.
- V2 is an example of a parameter.
- UG makes head-movement available for all languages. Some employ it in I^0 -to- C^0 movement, which produces the strings that can receive the descriptive label “verb second”.

Alright. So this is I^0 -to- C^0 movement.

But how does the verb get to I^0 to begin with?

- via head movement from within the VP: V^0 -to- I^0 movement

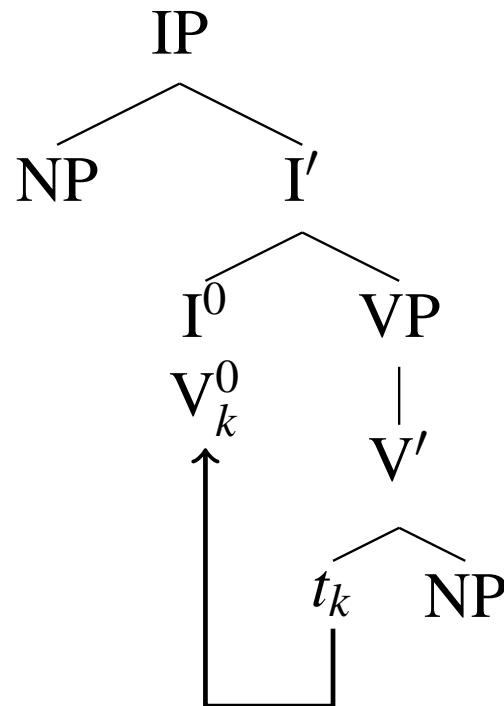

V⁰ to I⁰ to C⁰

How do we know that it is the V⁰+I⁰ complex that moves up to C⁰ and not just I⁰ or V⁰ by itself?

Because the verb appears in C⁰ completely inflected.

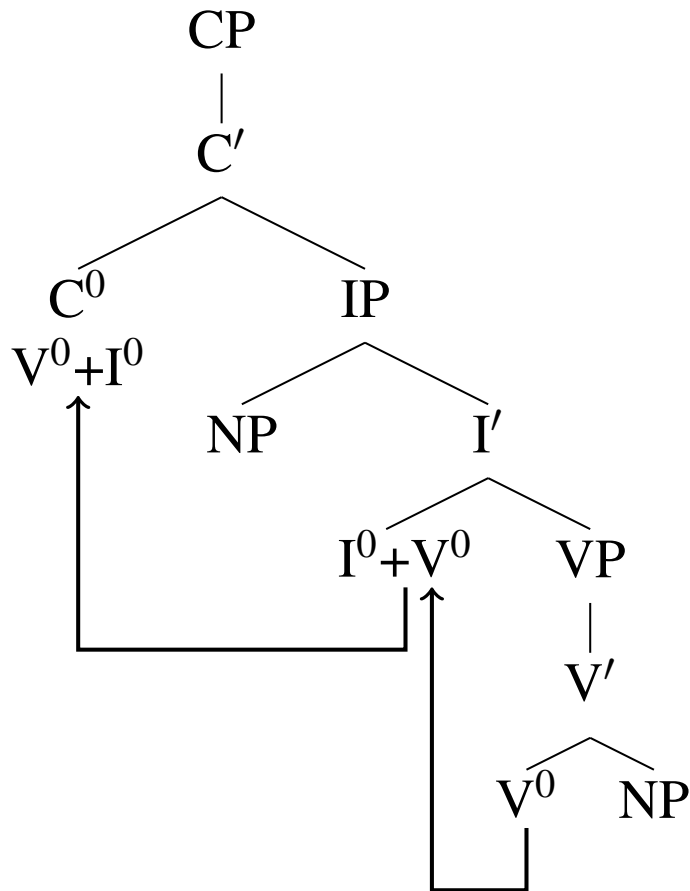

- To see V^0 -to- I^0 movement in simple action, one should really not look at English, because English has the added complication of *do*-insertion.
- So best to leave the question of English V^0 -to- I^0 for a more advanced class.
- A straightforward language to study V^0 -to- I^0 in is French.
- We saw that I^0 -to- C^0 movement was triggered by among others, the need to form questions in English.

What might trigger V^0 -to- I^0 ?

The need to get Tense and Agreement on the verb.

This predicts that a verb with tense and agreement will be in a different position in the tree than an infinitival verb.

- So can how we tell whether V^0 -to- I^0 has taken place?
- Well, how could we tell if I^0 -to- C^0 movement took place?
- It affects the word order! The verb appears before the subject.

46d.

Who must she interview?

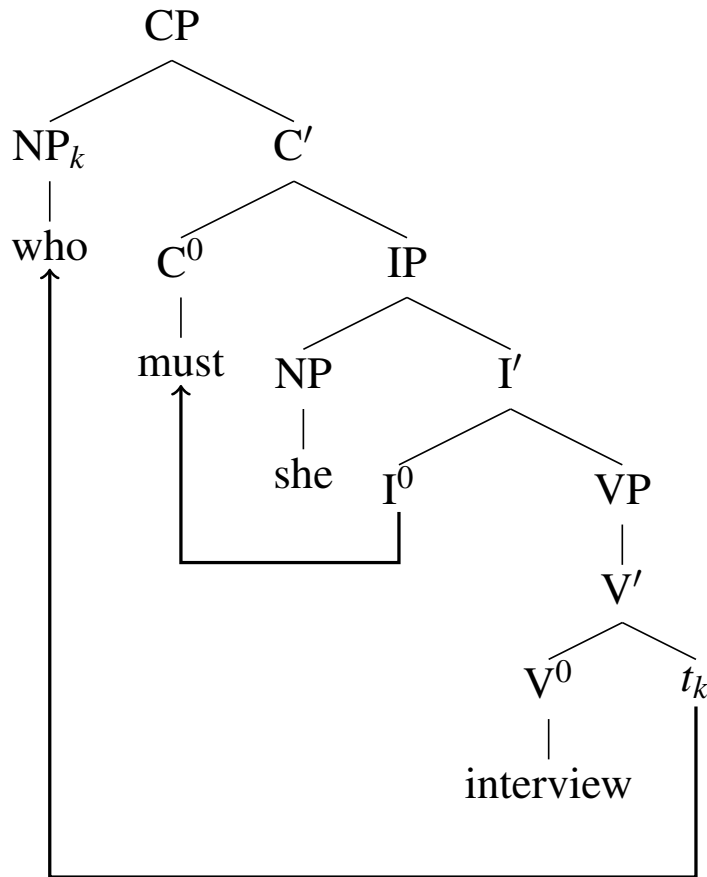

Maybe we should look for similar effects on word order with V^0 -to- I^0 movement: Let's assume that there is an element α , of which we are certain that it is generated under I^0 but above the VP. If, in a tensed sentence, the finite verb appears to the left of α , we can conclude that it has moved to I^0 . If the finite verb appears to the right of α , we can conclude that it did not move to I^0 . The infinitival verb would be predicted to appear after α .

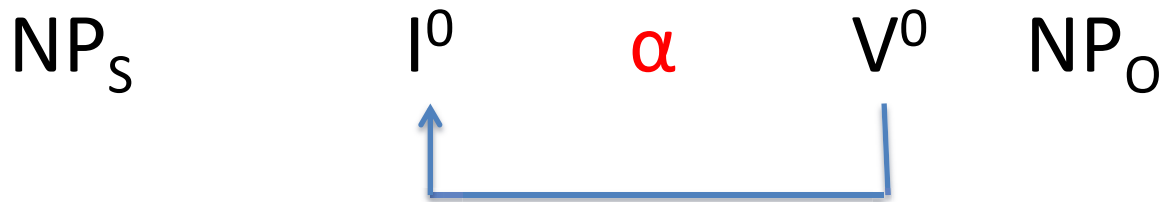

$NP_S \quad V \quad \alpha \quad NP_O \quad \rightarrow \quad V^0 \text{-to-} I^0$

$NP_S \quad \alpha \quad V \quad NP_O \quad \rightarrow \quad \text{no } V^0 \text{-to-} I^0$

- What are possible candidates for α ?
 - Negation
 - (certain) adverbs
- Prediction, just looking at negation:

verb+T+A: NP_S V Neg NP_0

infinitival verb: NP_S Neg V NP_0

(Emonds, Pollock)

The verb moving to pick up Tense and Agreement

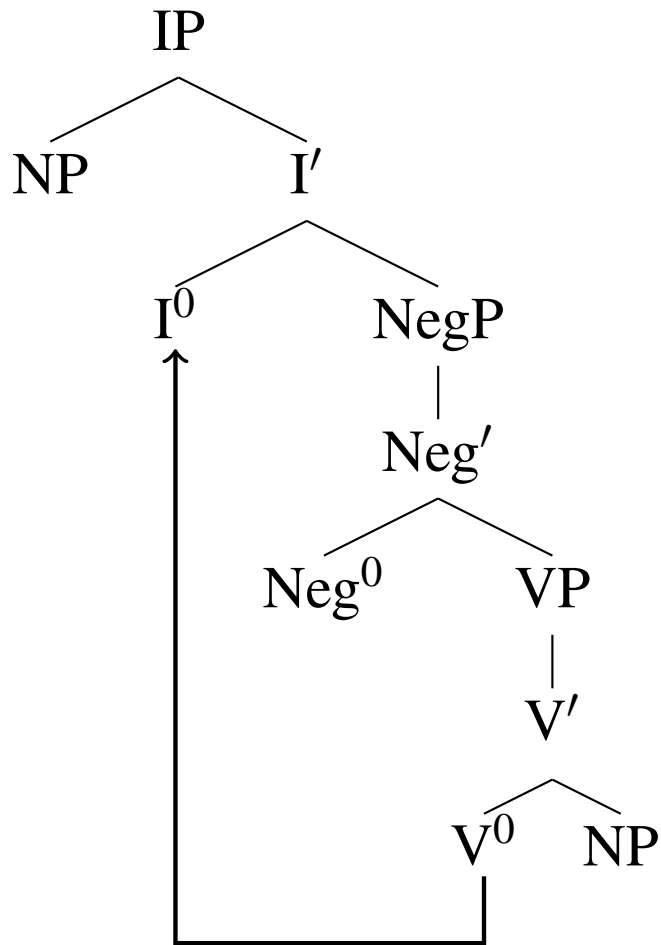

The prediction is verified:

68a. Pierre (ne) voit pas Marie
Peter sees not Marie
“Peter does not see Marie”

b.* Pierre (ne) pas voit Marie
Peter not sees Marie

69a. Ne pas voir Marie est stupide
neg see Marie is stupid
“To not see Marie is stupid”

b.* Ne voir pas Marie est stupide
see neg Marie is stupid

MIT OpenCourseWare
<http://ocw.mit.edu>

24.902 / 24.932 Language and its Structure II: Syntax
Fall 2015

For information about citing these materials or our Terms of Use, visit: <http://ocw.mit.edu/terms>.