

# Optimization Problems,

---

John Guttag

MIT Department of Electrical Engineering and  
Computer Science

# Relevant Reading for Today's Lecture

---

- Chapter 13



# Brute Force Algorithm

---

- 1. Enumerate all possible combinations of items.
- 2. Remove all of the combinations whose total units exceeds the allowed weight.
- 3. From the remaining combinations choose any one whose value is the largest.

# Search Tree Implementation

---

- The tree is built top down starting with the root
- The first element is selected from the still to be considered items
  - If there is room for that item in the knapsack, a node is constructed that reflects the consequence of choosing to take that item. By convention, we draw that as the left child
  - We also explore the consequences of not taking that item. This is the right child
- The process is then applied **recursively** to non-leaf children
- Finally, chose a node with the highest value that meets constraints

# A Search Tree Enumerates Possibilities

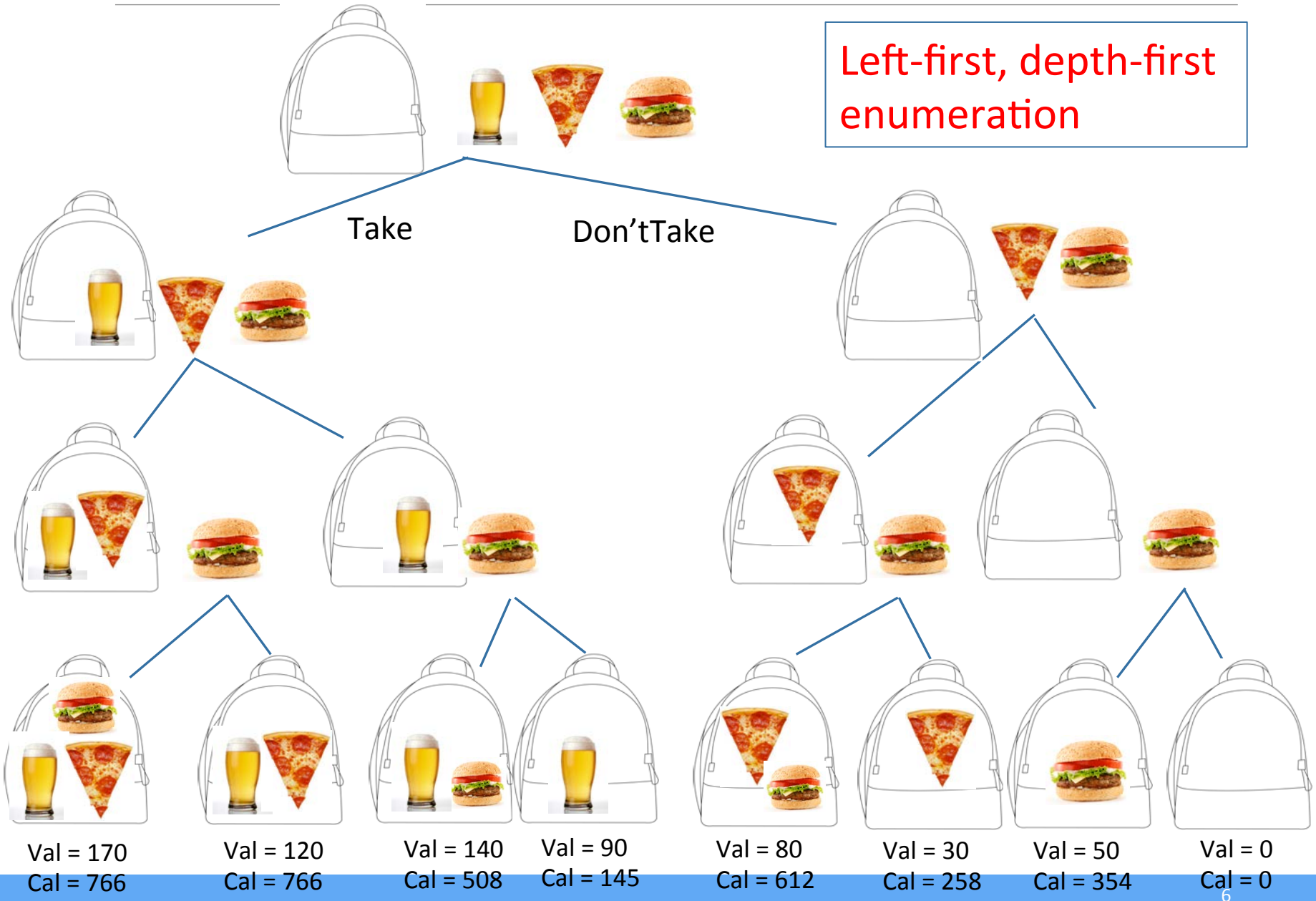



Image © source unknown. All rights reserved. This content is excluded from our Creative Commons license. For more information, see <https://ocw.mit.edu/help/faq-fair-use>.

# Computational Complexity

---

- Time based on number of nodes generated
- Number of levels is number of items to choose from
- Number of nodes at level  $i$  is  $2^i$
- So, if there are  $n$  items the number of nodes is
  - $\sum_{i=0}^{i=n} 2^i$
  - I.e.,  $O(2^{n+1})$
- An obvious optimization: don't explore parts of tree that violate constraint (e.g., too many calories)
  - Doesn't change complexity
- Does this mean that brute force is never useful?
  - Let's give it a try



# Header for Decision Tree Implementation

---

```
def maxVal(toConsider, avail):  
    """Assumes toConsider a list of items,  
        avail a weight  
    Returns a tuple of the total value of a  
        solution to 0/1 knapsack problem and  
        the items of that solution"""
```

`toConsider`. Those items that nodes higher up in the tree (corresponding to earlier calls in the recursive call stack) have not yet considered

`avail`. The amount of space still available

# Body of maxVal (without comments)

---

```
if toConsider == [] or avail == 0:
    result = (0, ())
elif toConsider[0].getUnits() > avail:
    result = maxVal(toConsider[1:], avail)
else:
    nextItem = toConsider[0]
    withVal, withToTake = maxVal(toConsider[1:],
                                avail - nextItem.getUnits())
    withoutVal, withoutToTake = maxVal(toConsider[1:], avail)
    if withVal > withoutVal:
        result = (withVal, withToTake + (nextItem,))
    else:
        result = (withoutVal, withoutToTake)
return result
```

Does not actually build search tree

Local variable `result` records best solution found so far

# Try on Example from Lecture 1

---

- With calorie budget of 750 calories, chose an optimal set of foods from the menu

Food	wine	beer	pizza	burger	fries	coke	apple	donut
Value	89	90	30	50	90	79	90	10
calories	123	154	258	354	365	150	95	195

# Search Tree Worked Great

---

- Gave us a better answer
- Finished quickly
- But  $2^8$  is not a large number
  - We should look at what happens when we have a more extensive menu to choose from

# Code to Try Larger Examples

---

```
import random ←  
  
def buildLargeMenu(numItems, maxVal, maxCost):  
    items = []  
    for i in range(numItems):  
        items.append(Food(str(i),  
                          random.randint(1, maxVal),  
                          random.randint(1, maxCost)))  
    return items  
  
for numItems in (5,10,15,20,25,30,35,40,45,50,55,60):  
    items = buildLargeMenu(numItems, 90, 250)  
    testMaxVal(items, 750, False)
```

# Is It Hopeless?

---

- In theory, yes
- In practice, no!
- Dynamic programming to the rescue

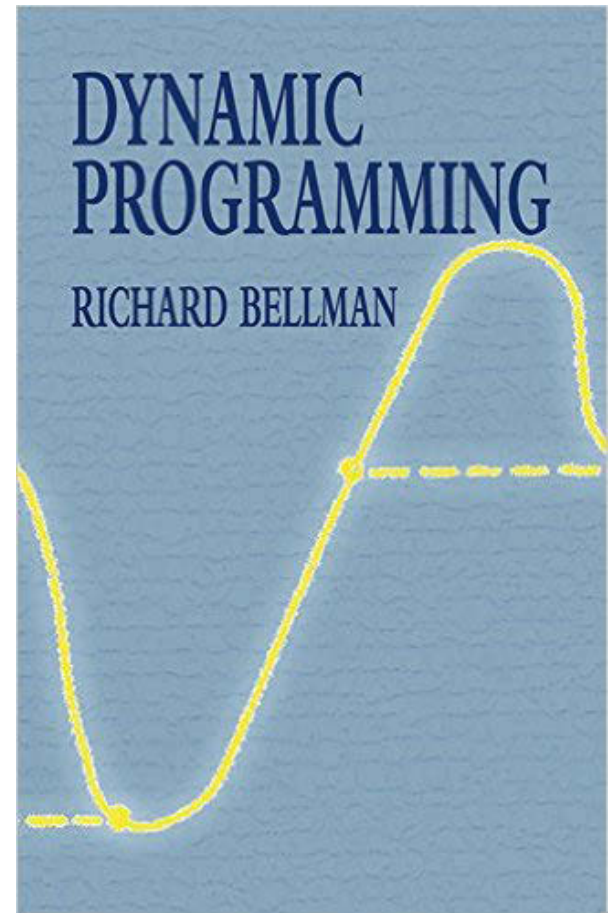

# Dynamic Programming?

---

Sometimes a name is just a name

“The 1950s were not good years for mathematical research... I felt I had to do something to shield Wilson and the Air Force from the fact that I was really doing mathematics... What title, what name, could I choose? ... It's impossible to use the word dynamic in a pejorative sense. Try thinking of some combination that will possibly give it a pejorative meaning. It's impossible. Thus, I thought dynamic programming was a good name. It was something not even a Congressman could object to. So I used it as an umbrella for my activities.

-- Richard Bellman

# Recursive Implementation of Fibonacci

---

```
def fib(n):  
    if n == 0 or n == 1:  
        return 1  
    else:  
        return fib(n - 1) + fib(n - 2)
```

`fib(120)` = 8,670,007,398,507,948,658,051,921



# Call Tree for Recursive Fibonacci(6) = 13

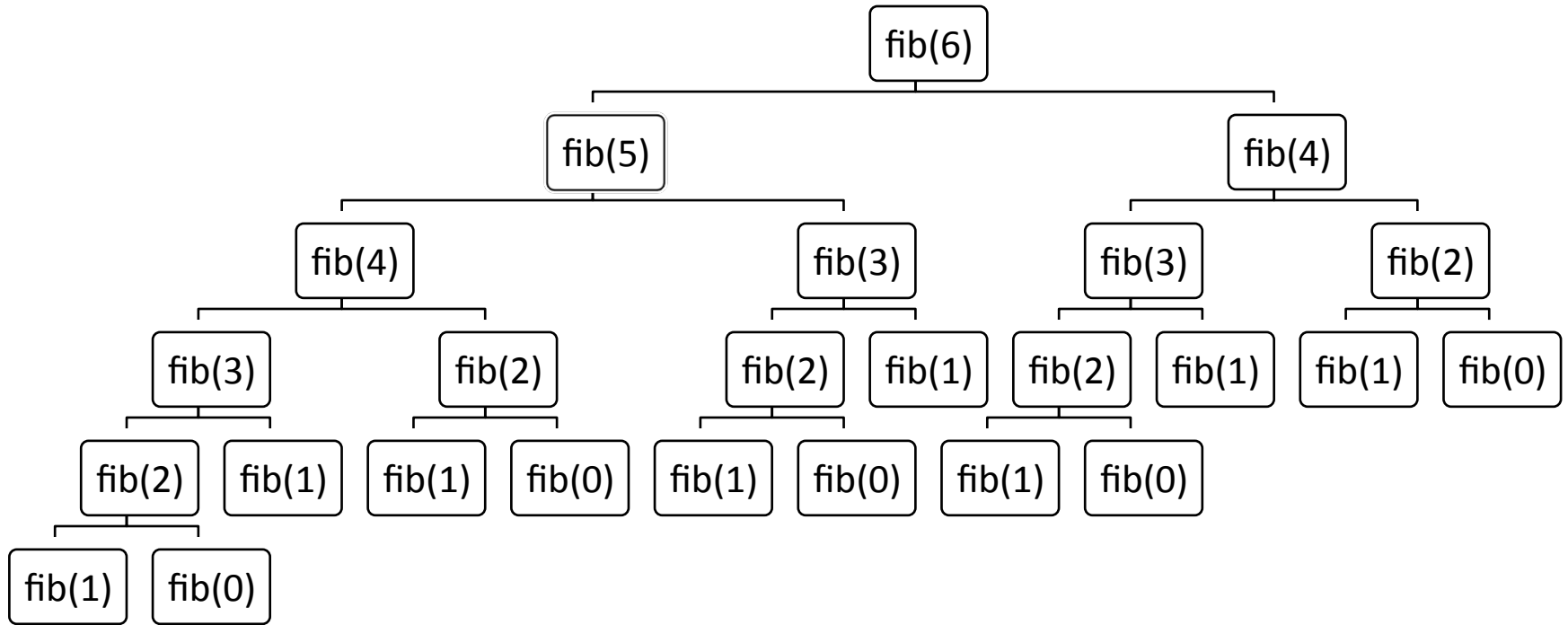

# Clearly a Bad Idea to Repeat Work

---

- Trade a time for space
- Create a table to record what we've done
  - Before computing  $\text{fib}(x)$ , check if value of  $\text{fib}(x)$  already stored in the table
    - If so, look it up
    - If not, compute it and then add it to table
  - Called **memoization**

# Using a Memo to Compute Fibonacci

---

```
def fastFib(n, memo = {}):
    """Assumes n is an int >= 0, memo used only by
        recursive calls
        Returns Fibonacci of n"""
    if n == 0 or n == 1:
        return 1
    try:
        return memo[n]
    except KeyError:
        result = fastFib(n-1, memo) + \
            fastFib(n-2, memo)
        memo[n] = result
    return result
```

# When Does It Work?

---

- **Optimal substructure**: a globally optimal solution can be found by combining optimal solutions to local subproblems
  - For  $x > 1$ ,  $\text{fib}(x) = \text{fib}(x - 1) + \text{fib}(x - 2)$
- **Overlapping subproblems**: finding an optimal solution involves solving the same problem multiple times
  - Compute  $\text{fib}(x)$  or many times

# What About 0/1 Knapsack Problem?

---

- Do these conditions hold?



Questions 2 and 3

# Search Tree

Optimal substructure?  
Overlapping subproblems?

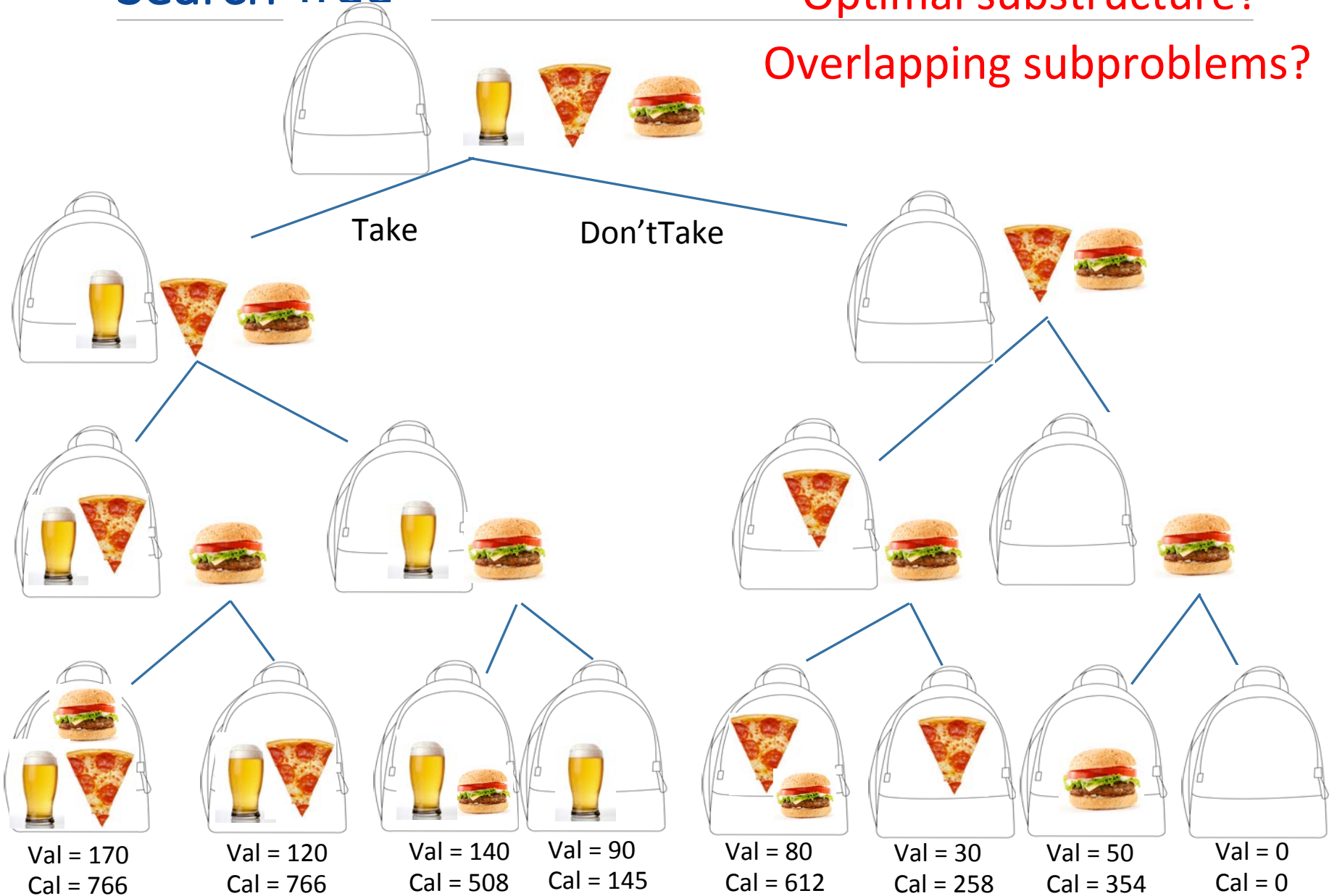

# A Different Menu

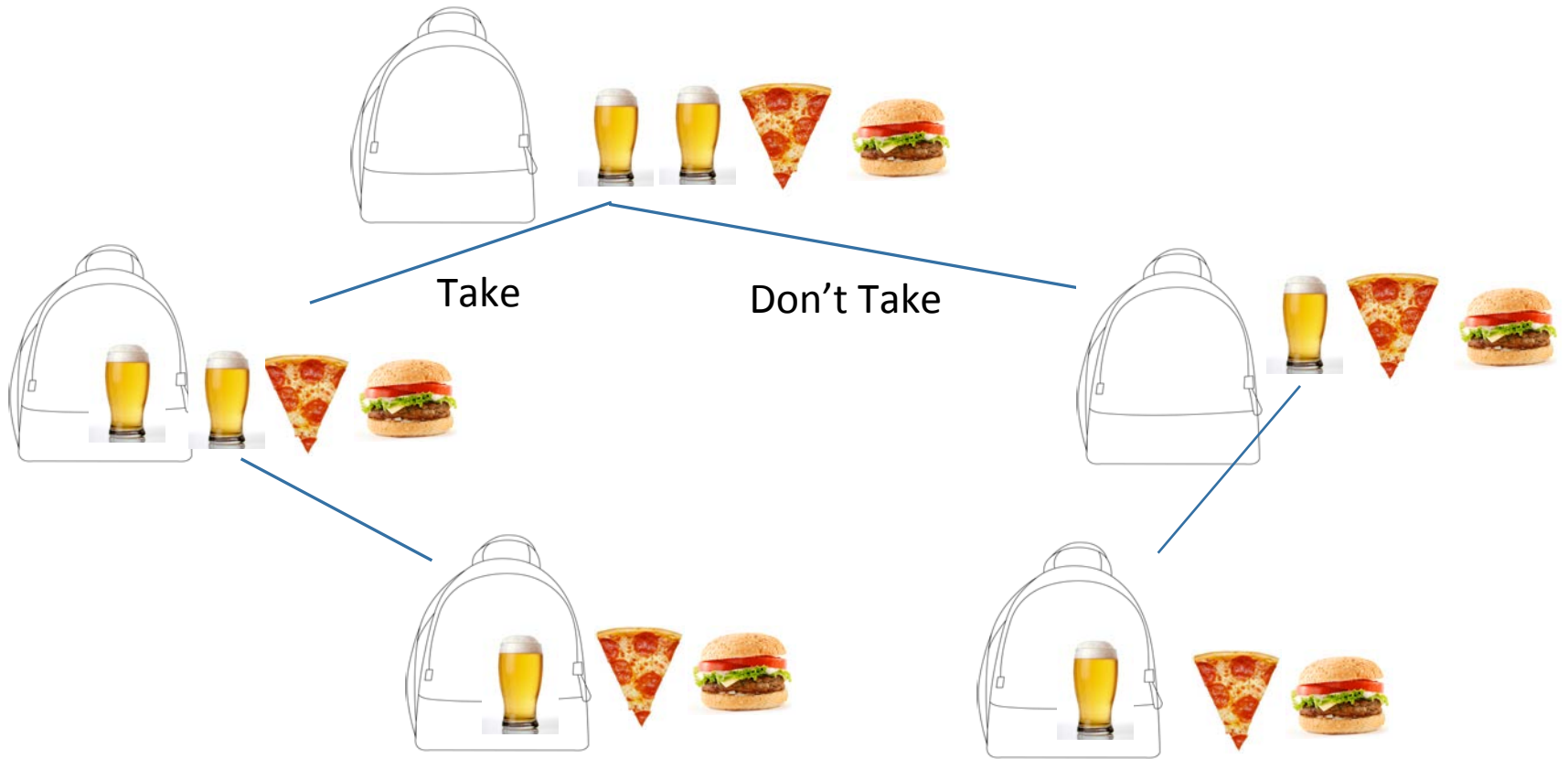

# Need Not Have Copies of Items

---

Item	Value	Calories
a	6	3
b	7	3
c	8	2
d	9	5



# Search Tree

- Each node = <taken, left, value, remaining calories>

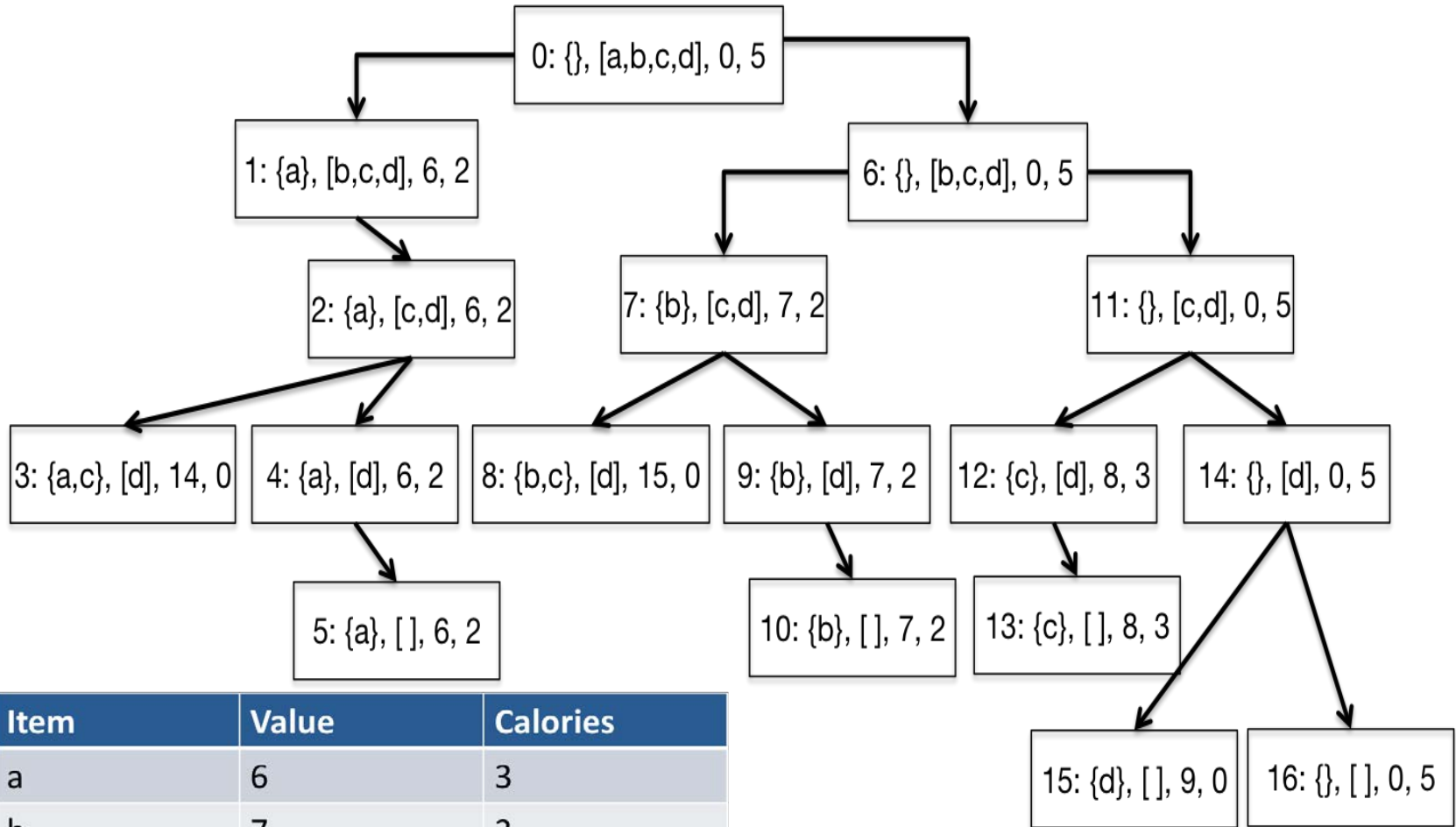

Item	Value	Calories
a	6	3
b	7	3
c	8	2
d	9	5

# What Problem is Solved at Each Node?

---

- Given remaining weight, maximize value by choosing among remaining items
- Set of previously chosen items, or even value of that set, doesn't matter!

# Overlapping Subproblems

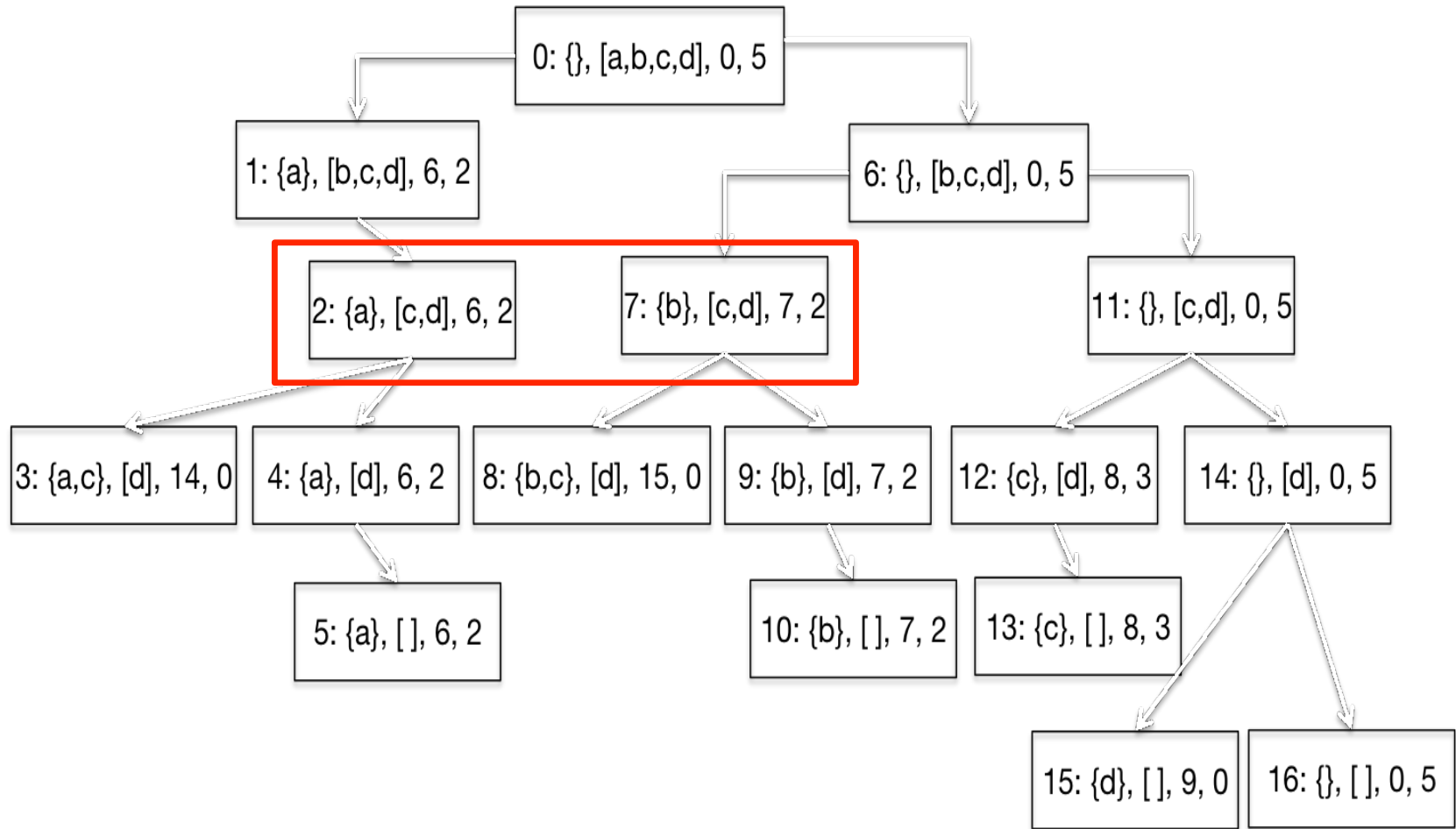

# Modify maxVal to Use a Memo

---

- Add memo as a third argument
  - `def fastMaxVal(toConsider, avail, memo = {}):`
- Key of memo is a tuple
  - (items left to be considered, available weight)
  - Items left to be considered represented by `len(toConsider)`
- First thing body of function does is check whether the optimal choice of items given the the available weight is already in the memo
- Last thing body of function does is update the memo

# Performance

---

len(items)	$2^{**}len(items)$	Number of calls
2	4	7
4	16	25
8	256	427
16	65,536	5,191
32	4,294,967,296	22,701
64	18,446,744,073,709,551,616	42,569
128	Big	83,319
256	Really Big	176,614
512	Ridiculously big	351,230
1024	Absolutely huge	703,802

# How Can This Be?

---

- Problem is exponential
- Have we overturned the laws of the universe?
- Is dynamic programming a miracle?
- No, but computational complexity can be subtle
- Running time of `fastMaxVal` is governed by number of distinct pairs, `<toConsider, avail>`
  - Number of possible values of `toConsider` bounded by `len(items)`
  - Possible values of `avail` a bit harder to characterize
    - Bounded by number of distinct sums of weights
    - Covered in more detail in assigned reading

# Summary of Lectures 1-2

---

- Many problems of practical importance can be formulated as **optimization problems**
- **Greedy algorithms** often provide adequate (though not necessarily optimal) solutions
- Finding an optimal solution is usually **exponentially hard**
- But **dynamic programming** often yields good performance for a subclass of optimization problems—those with optimal substructure and overlapping subproblems
  - Solution always correct
  - Fast under the right circumstances

# The “Roll-over” Optimization Problem

---

$$\text{Score} = ((60 - (a+b+c+d+e))*F + a*ps1 + b*ps2 + c*ps3 + d*ps4 + e*ps5$$

Objective:

Given values for F, ps1, ps2, ps3, ps4, ps5

Find values for a, b, c, d, e that maximize score

Constraints:

a, b, c, d, e are each 10 or 0

$a + b + c + d + e \geq 20$



MIT OpenCourseWare

<https://ocw.mit.edu>

6.0002 Introduction to Computational Thinking and Data Science

Fall 2016

For information about citing these materials or our Terms of Use, visit: <https://ocw.mit.edu/terms>.