

**Lectures 6 and 7**

**Site Characterization**

# Questions to be answered by site characterization

Nature and extent of contamination—  
where is it?

What is future migration and control—  
where is it going?

What are receptors and their risk—  
what harm will it do?

What are technical options for remediation—  
how do we fix it?

# Data needed from site characterization

1. Contaminant sources – research history as well as collect samples
2. Extent of contamination – need to understand transport as well
3. Hydrogeologic setting – use to address items 1 and 2
4. Restoration potential

# Stages of investigation

Stage 1 – scoping study

Is there a problem? How bad is it?

Stage 2 – prepare field study plan

Includes sampling and analysis, health and safety, and quality assurance plans

Stage 3 – conduct on-site sampling and analysis

Stage 4 – interpretation, assessment, modeling

(Stages 3 and 4 may be iterative)

Stage 5 – design remedial action

# First steps in understanding a site

## 1. Get a USGS topo map!

Understand geographic setting, topography, nearby water bodies

## 2. Get background geologic data

Consult ground-water atlas of the U.S.

Get reports on geology, hydrology, meteorology

Check for reports from state and U.S. geological surveys

# First steps in understanding a site

## 3. Understand site use and history

Where were chemicals handled or disposed?

What site structures or activities are potential sources?

What chemicals are and were handled?

# Background information is important

Regional geology helps you understand site geology and hydrology

Regional hydrogeology may have significant effect on contaminant movement

Prevents costly mistakes such as multi-aquifer wells

# Health and safety Level A



U.S. Environmental Protection Agency, September 30, 2002. Emergency Response Program. United States Environmental Protection Agency. Washington, D.C. <http://www.epa.gov/superfund/programs/er/resource/photos1.htm>. Accessed December 20, 2002.



# Health and Safety Levels

Safety Level	Equipment	Labor Productivity	Equipment Productivity
A	“Moon suit”	37%	50%
B	SCUBA; facial mask	48%	60%
C	Respirator; Tyvec suit	55%	75%
D	Normal work protection	82%	100%
E	No personal protection equip.	100%	100%

# Soil gas sampling system

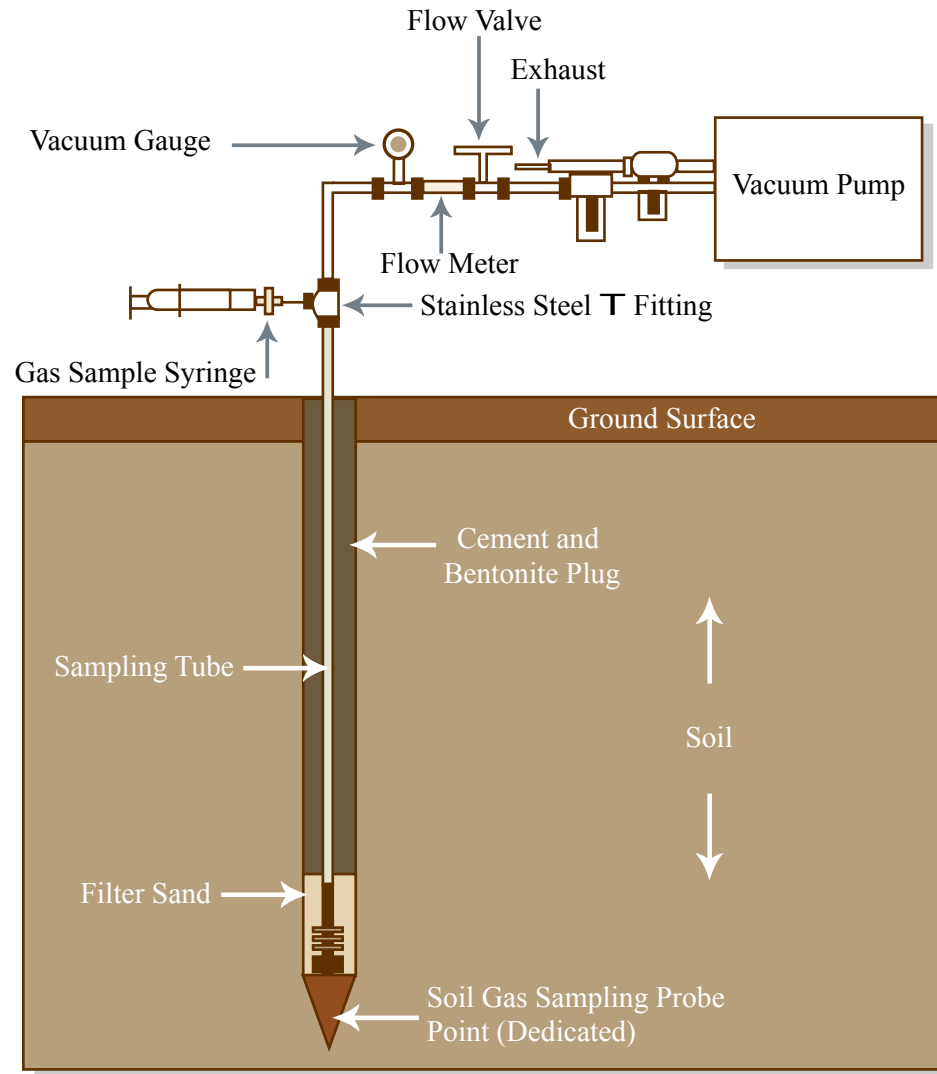

Adapted from: Environmental Support Technologies, Inc., undated. *Soil Gas Surveying*. Environmental Support Technologies, Inc. Irvine, CA. [www.est-inc.com/soil-gas.htm](http://www.est-inc.com/soil-gas.htm). Accessed December 17, 2002.

Soil gas survey is a good qualitative technique to assess areas on a site where contamination is likely. Output is an indication of the chemicals present and their relative concentrations.

# Soil vapor sampling

See images of soil vapor sampling at the Web site of Environmental Support Technologies, Inc., Irvine, CA:

<http://www.est-inc.com/soil-gas.htm>

(Accessed December 17, 2002.)

# Output from field GC

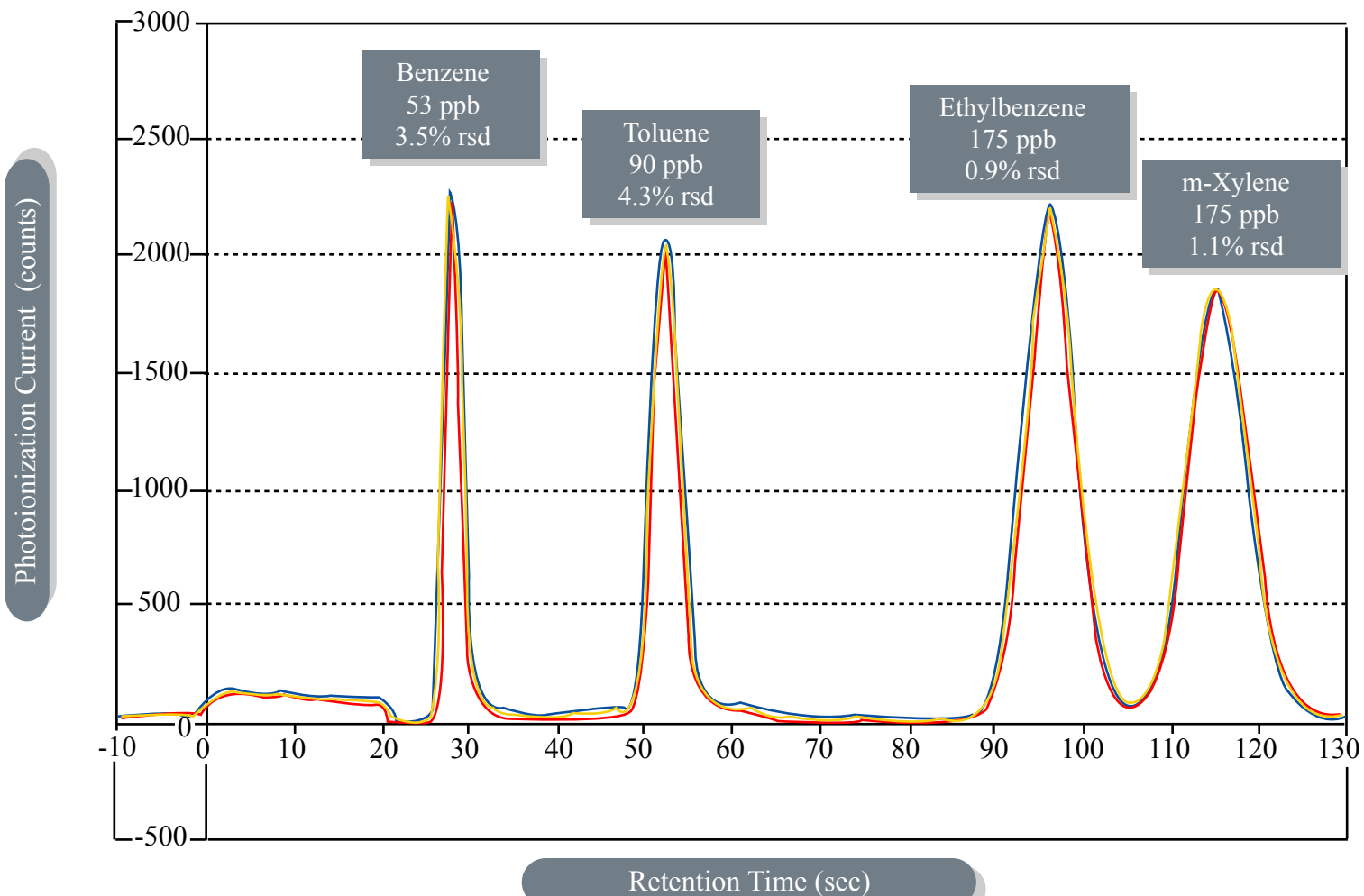

Adapted from: Ebersold, P. J. and N. Baker. "Having a Field Day." *Environmental Protection* 14, no. 3 (April 2003): 45-49.

# Soil gas survey results

Iso-Concentration Contour Map (Micrograms per liter)

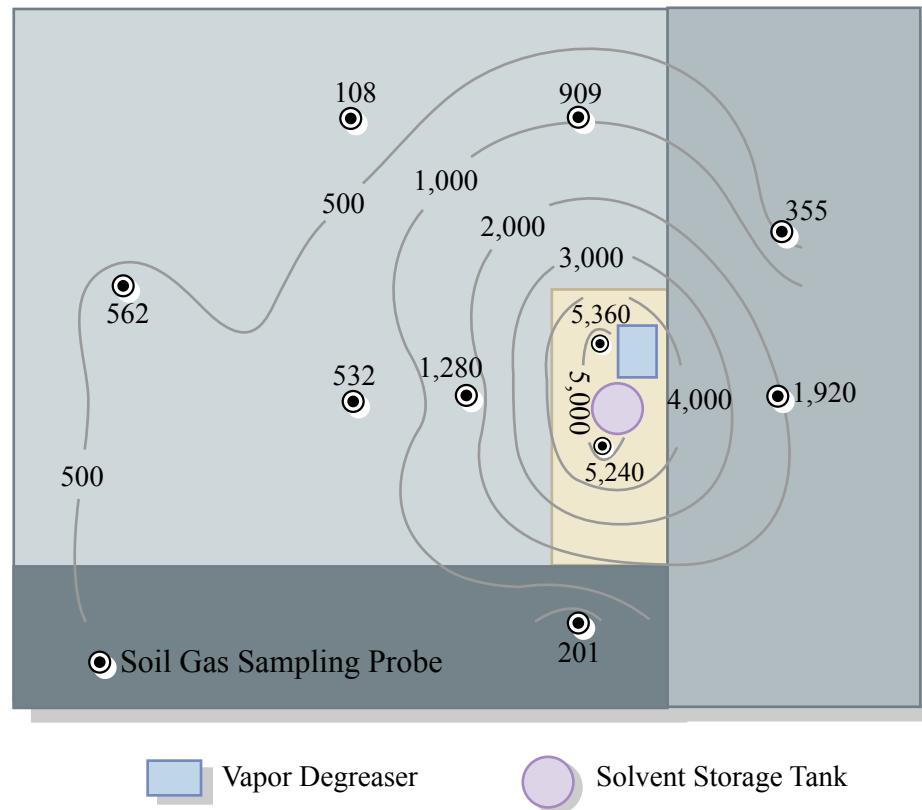

Adapted from: *Soil Gas Surveying*. Environmental Support Technologies, Inc. (undated) Irvine, CA.  
[www.est-inc.com/soil-gas.htm](http://www.est-inc.com/soil-gas.htm). Accessed December 17, 2002.

# Potential character of soil gas contamination

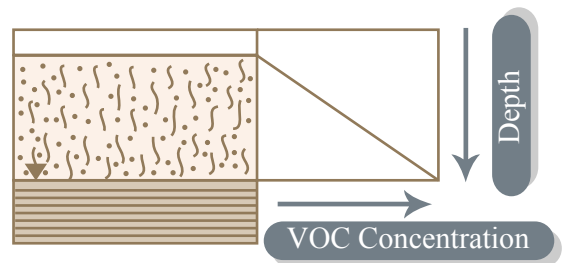

Homogeneous porous material with sufficient air-filled porosity

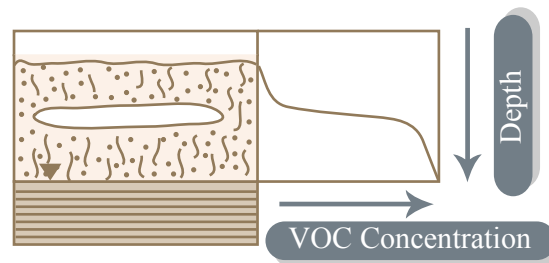

Impermeable subsurface layer (e.g., clay or perched water)

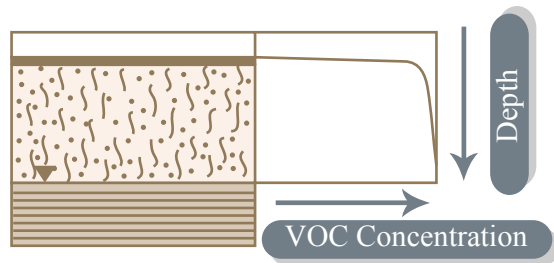

Impermeable surface layer (e.g., pavement)

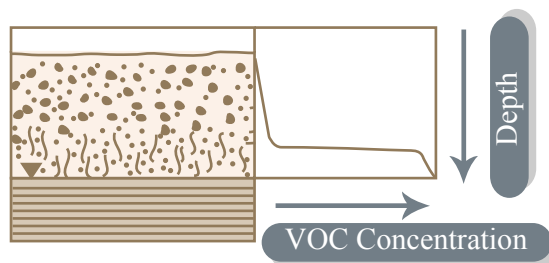

Zone of high microbiological activity (circles and wavy lines indicate different compounds)

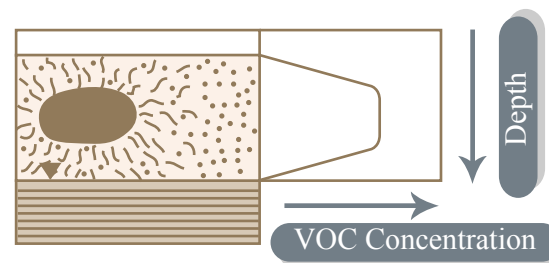

VOC source in the vadose zone

# Observed soil gas contamination pattern

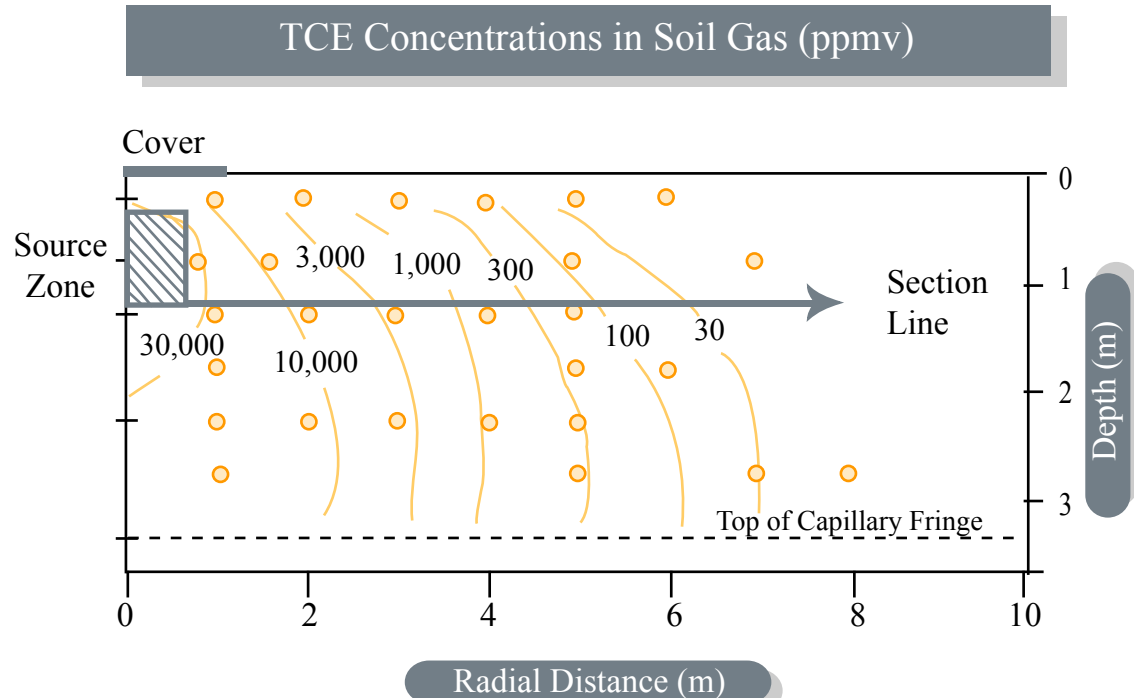

Example of lateral transport of TCE vapor in a sandy aquifer resulting from an experimental placement of a DNAPL source in the vadose zone. This vapor distribution developed 18 days after placement of a source zone that contained 42 L of TCE.

Adapted from: Pankow, J. F. and J. A. Cherry. *Dense Chlorinated Solvents and Other DNAPLS in Groundwater*. Portland, Oregon: Waterloo Press, 1996.

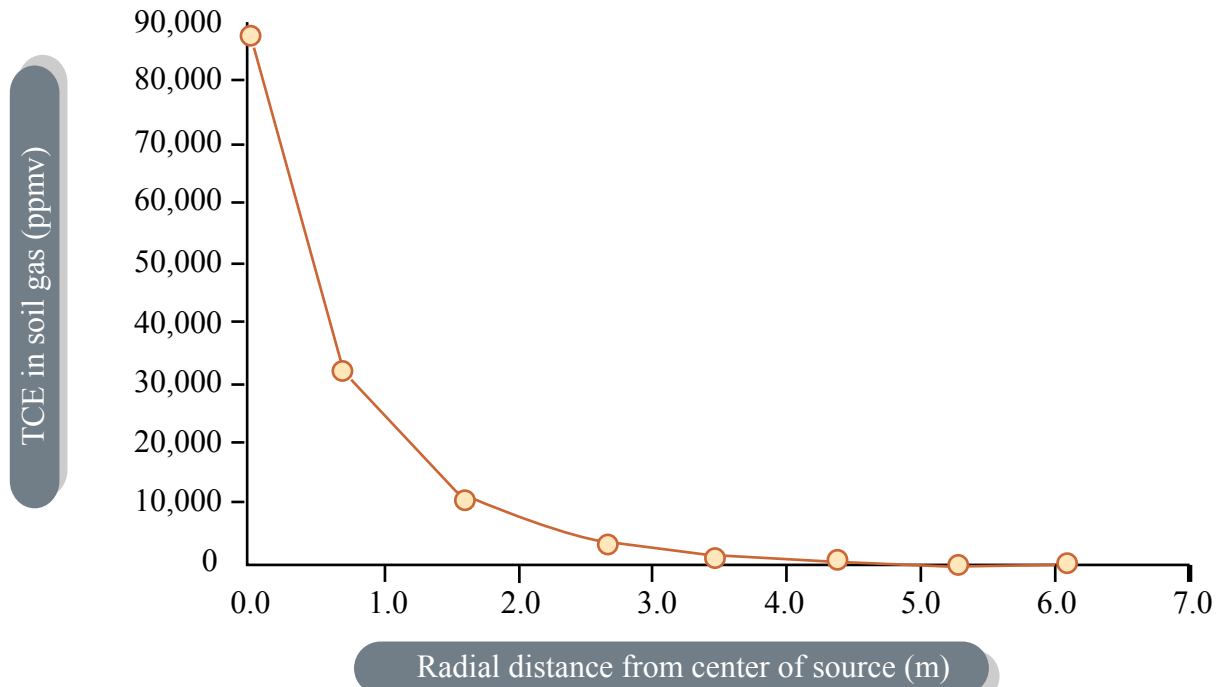

Example of the decline in TCE vapor concentrations with distance from the DNAPL source in the vadose zone. This profile corresponds to the section line shown in the figure on the previous slide.

Adapted from: Pankow, J. F. and J. A. Cherry. *Dense Chlorinated Solvents and Other DNAPLS in Groundwater*. Portland, Oregon: Waterloo Press, 1996.



# Passive soil gas collector

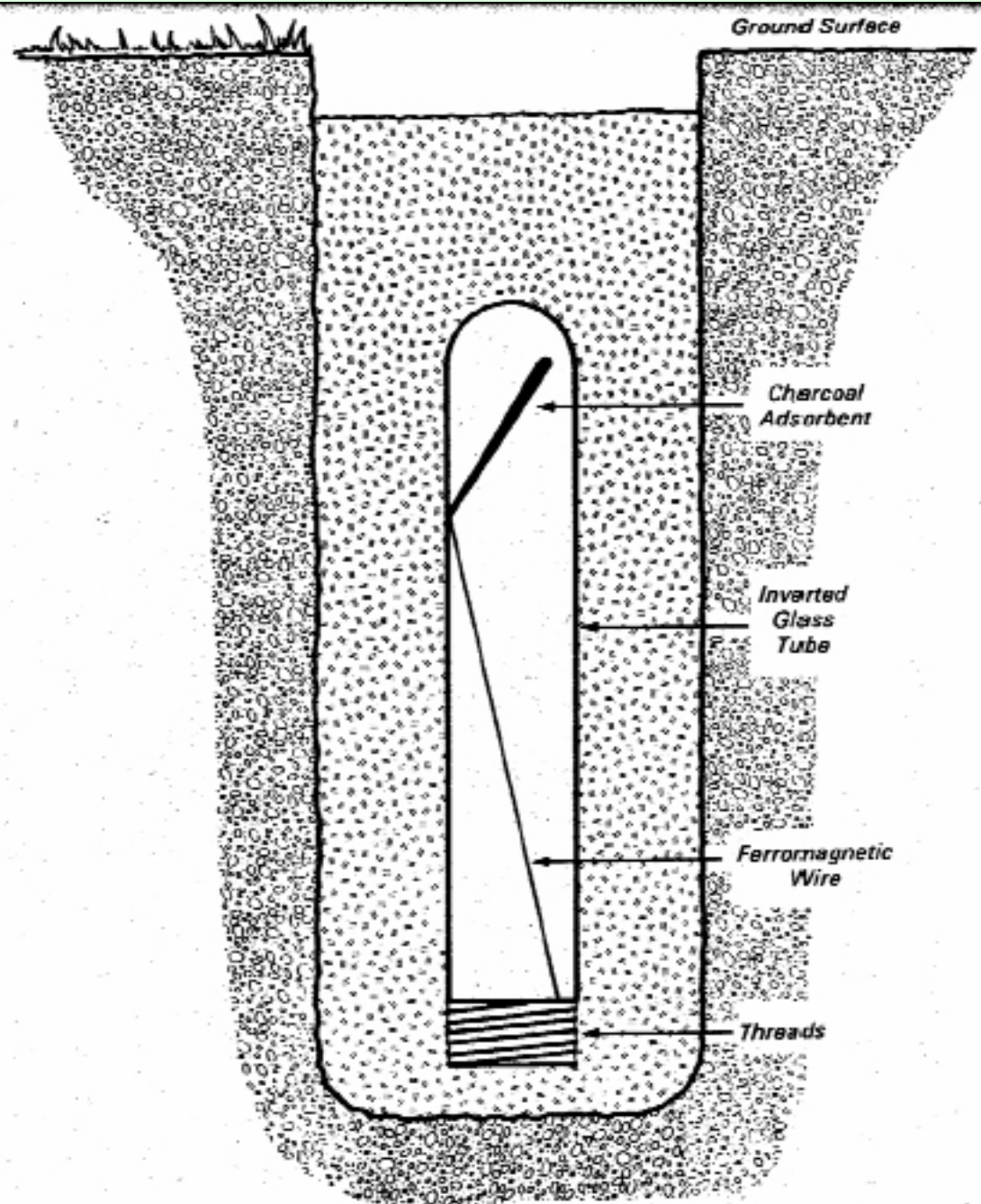

Source: U.S. EPA, 1993. Subsurface characterization and monitoring techniques: A desk reference guide. Report Number EPA/625/R-93/003. Center for Environmental Research Information, U.S. Environmental Protection Agency, Cincinnati, Ohio. May 1993. Figure 9.4.1, pg. 9-39.

# Passive diffusion sampler for water phase

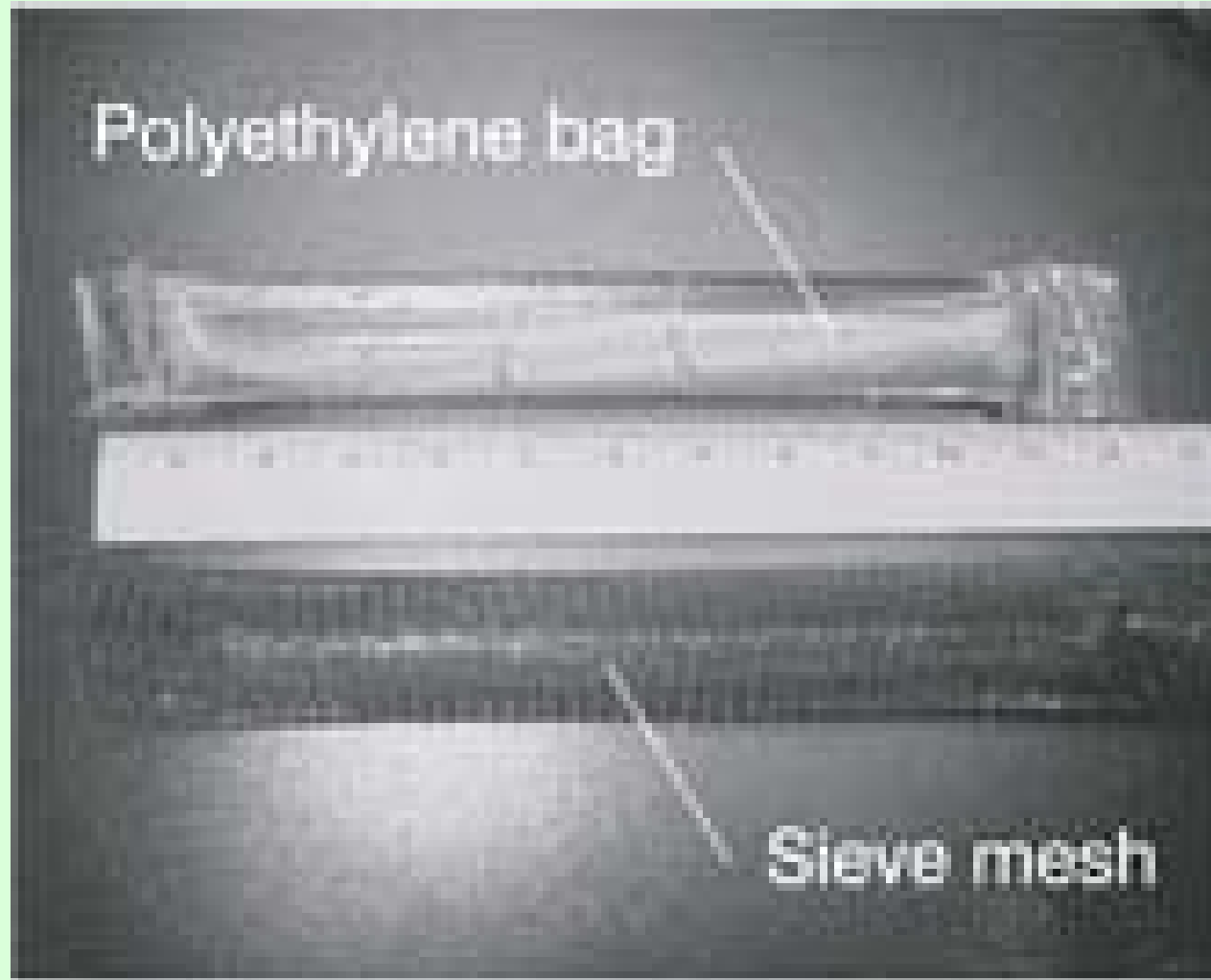

Source: United States Geological Survey, August 23, 2001. Water Resources of New Hampshire and Vermont: New Contaminant Sampling Method Tested at Superfund Site in Milford, MA. U.S. Department of the Interior, U.S. Geological Survey, New Hampshire/Vermont District. Pembroke, NH. <http://vt.water.usgs.gov/.../2001Newsletter/contaminant.htm>. Accessed January 11, 2002.

# Diffusion sampler results for Ashumet Pond, Cape Cod

Source: Savoie, J. G., D. R. LeBlanc, D. S. Blackwood, T. D. McCobb, R. R. Rendigs, and S. Clifford, 2000. Delineation of Discharge Areas of Two Contaminant Plumes by Use of Diffusion Samplers, Johns Pond, Cape Cod, Massachusetts, 1998. Water-Resources Investigations Report 00-4017. U.S. Geological Survey, Northborough, Massachusetts.

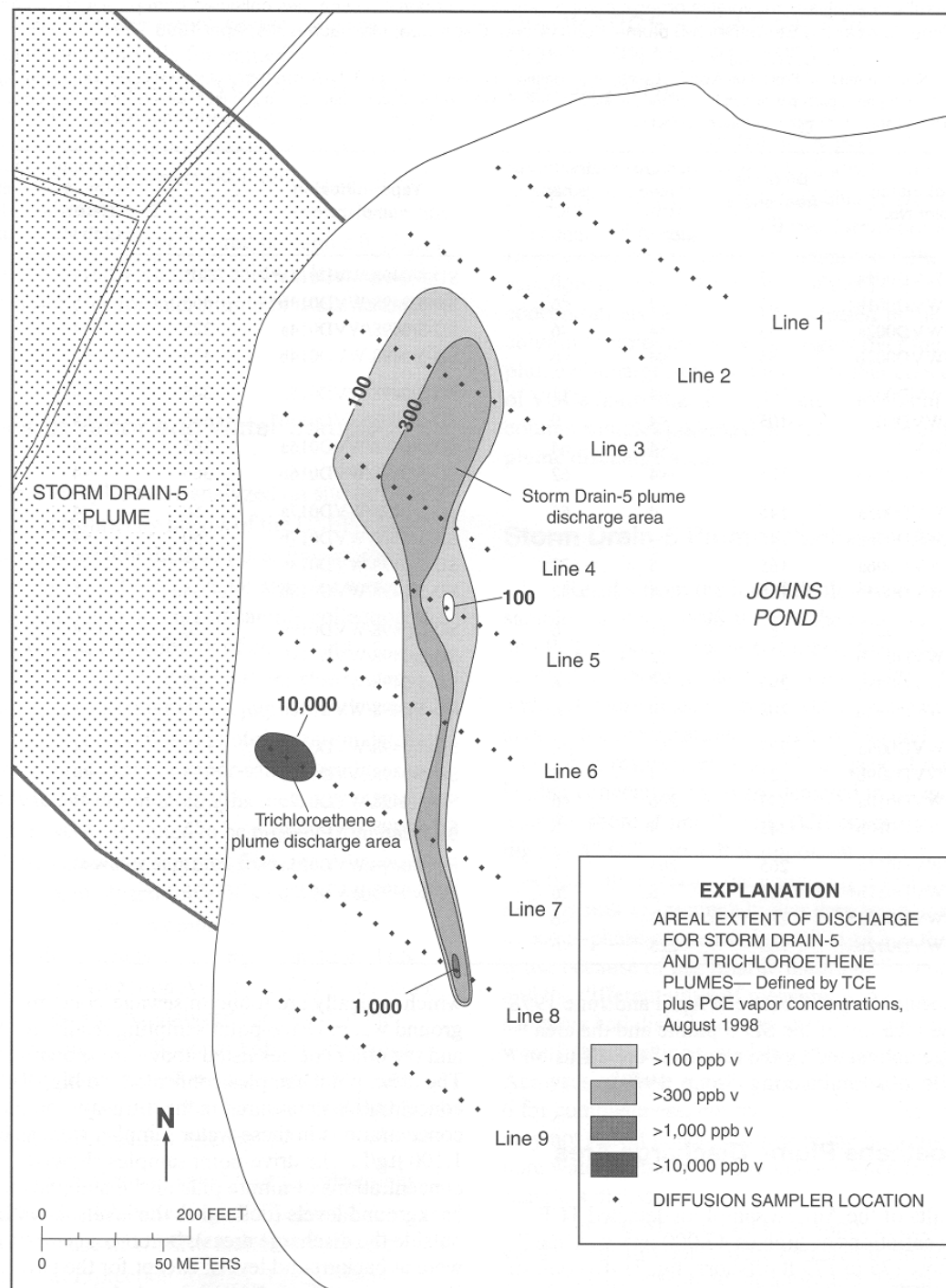

# Field vapor analyzers

OVA Flame Ionization  
Detector – aliphatics,  
aromatics, haloethanes,  
Halomethanes

HNu Photoionization  
Detector – aliphatics and  
aromatics

# Field vapor analyzer in use



Source: Environmental Protection Agency, Region 10 Inspection Office. <http://www.epa.gov/r10earth/offices/oea/ieu/manual/gallery.htm>. Accessed May 11, 2004.

# Geophysical Methods

Method	Object
Electrical resistivity	Map conductive or nonconductive contaminants; stratigraphy
Electromagnetic induction	Map conductive or nonconductive contaminants; metal objects; stratigraphy
Seismic refraction	Stratigraphy (top of bedrock); depth to ground water
Seismic reflection	High resolution mapping of top of bedrock
Ground penetrating radar (GPR)	Buried objects (plastic and metal); stratigraphy; depth to ground water
Magnetometry	Buried metal objects
Gravity survey	Overburden thickness; landfill boundaries

# Ground penetrating radar

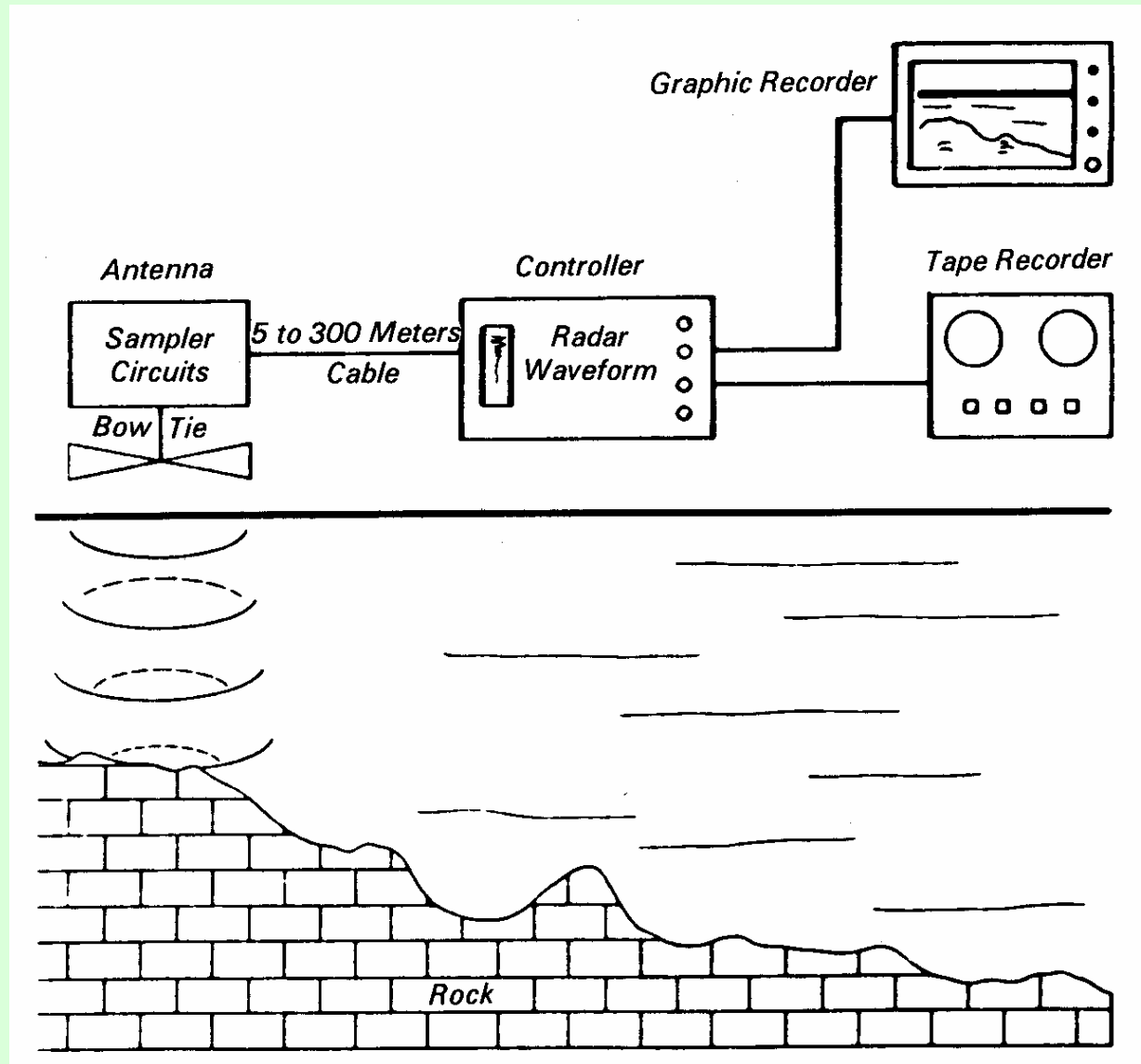

Source: van Ea, J. J., 1985. Project Summary: Geophysical Techniques for Sensing Buried Wastes and Waste Migration. Report Number EPA/600/S7-84/064. Environmental Monitoring Systems Laboratory, U.S. Environmental Protection Agency, Las Vegas, Nevada. May 1985.

# Electromagnetic Induction

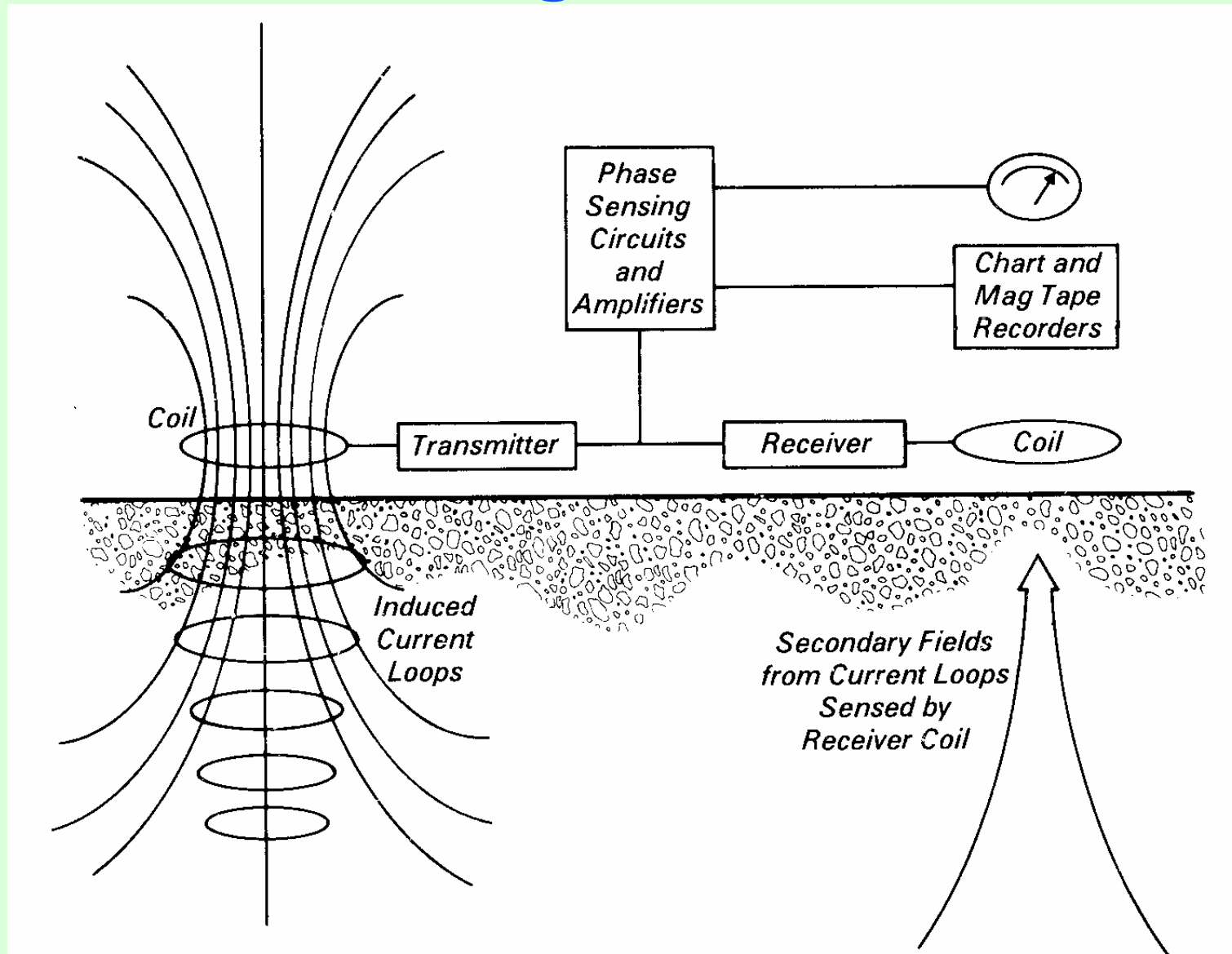

Source: van Ea, J. J., 1985. Project Summary: Geophysical Techniques for Sensing Buried Wastes and Waste Migration. Report Number EPA/600/S7-84/064. Environmental Monitoring Systems Laboratory, U.S. Environmental Protection Agency, Las Vegas, Nevada. May 1985.



# Electrical resistivity

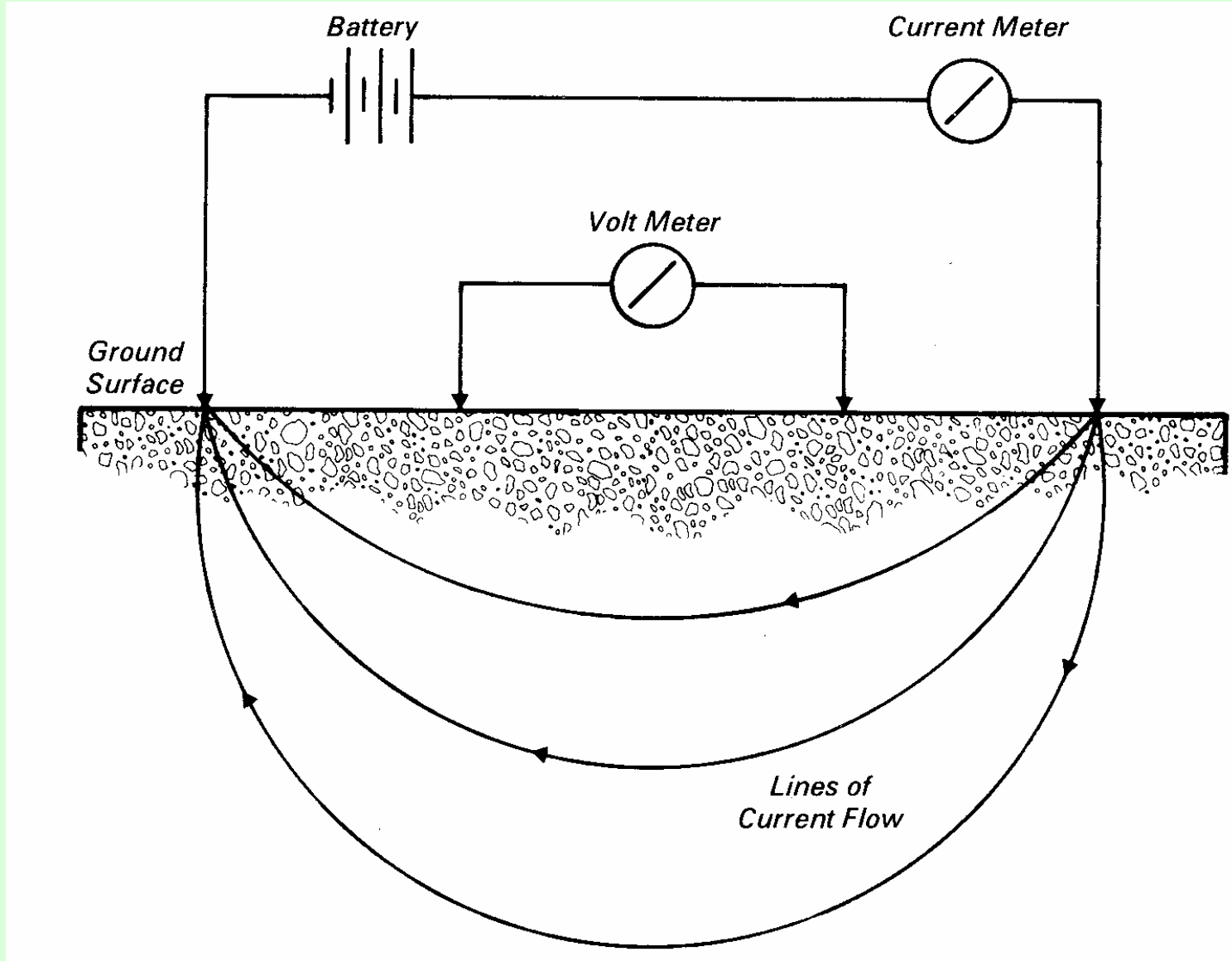

Source: van Ea, J. J., 1985. Project Summary: Geophysical Techniques for Sensing Buried Wastes and Waste Migration. Report Number EPA/600/S7-84/064. Environmental Monitoring Systems Laboratory, U.S. Environmental Protection Agency, Las Vegas, Nevada. May 1985.

# Seismic reflection

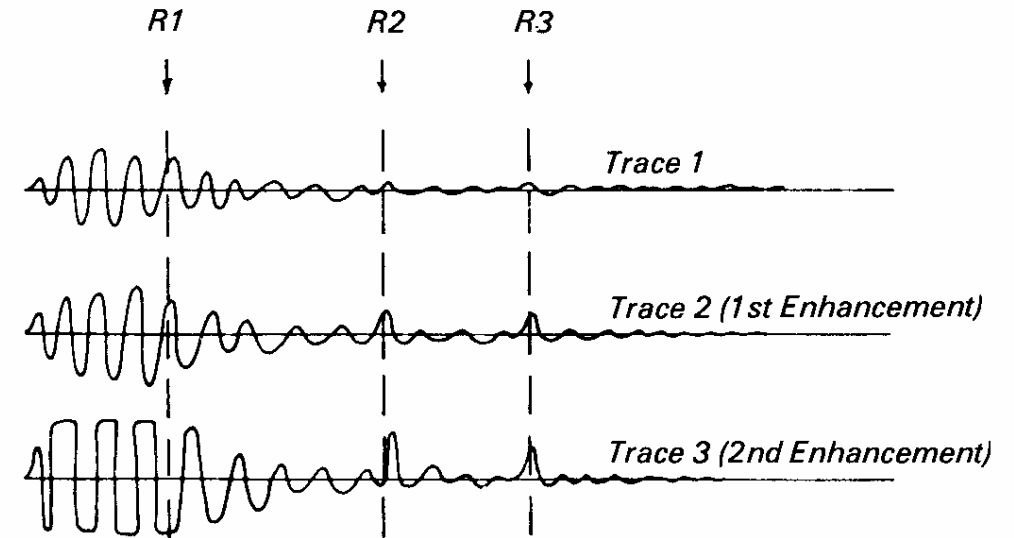
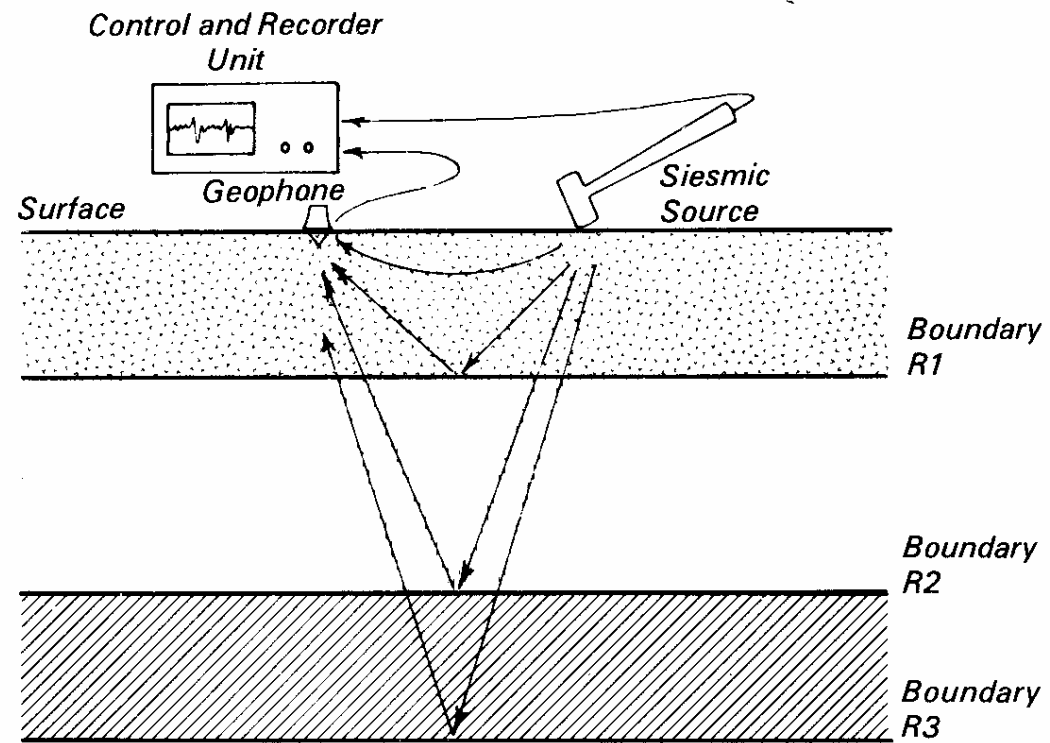

Source: van Ea, J. J., 1985. Project Summary: Geophysical Techniques for Sensing Buried Wastes and Waste Migration. Report Number EPA/600/S7-84/064. Environmental Monitoring Systems Laboratory, U.S. Environmental Protection Agency, Las Vegas, Nevada. May 1985.

# Geophysics suite

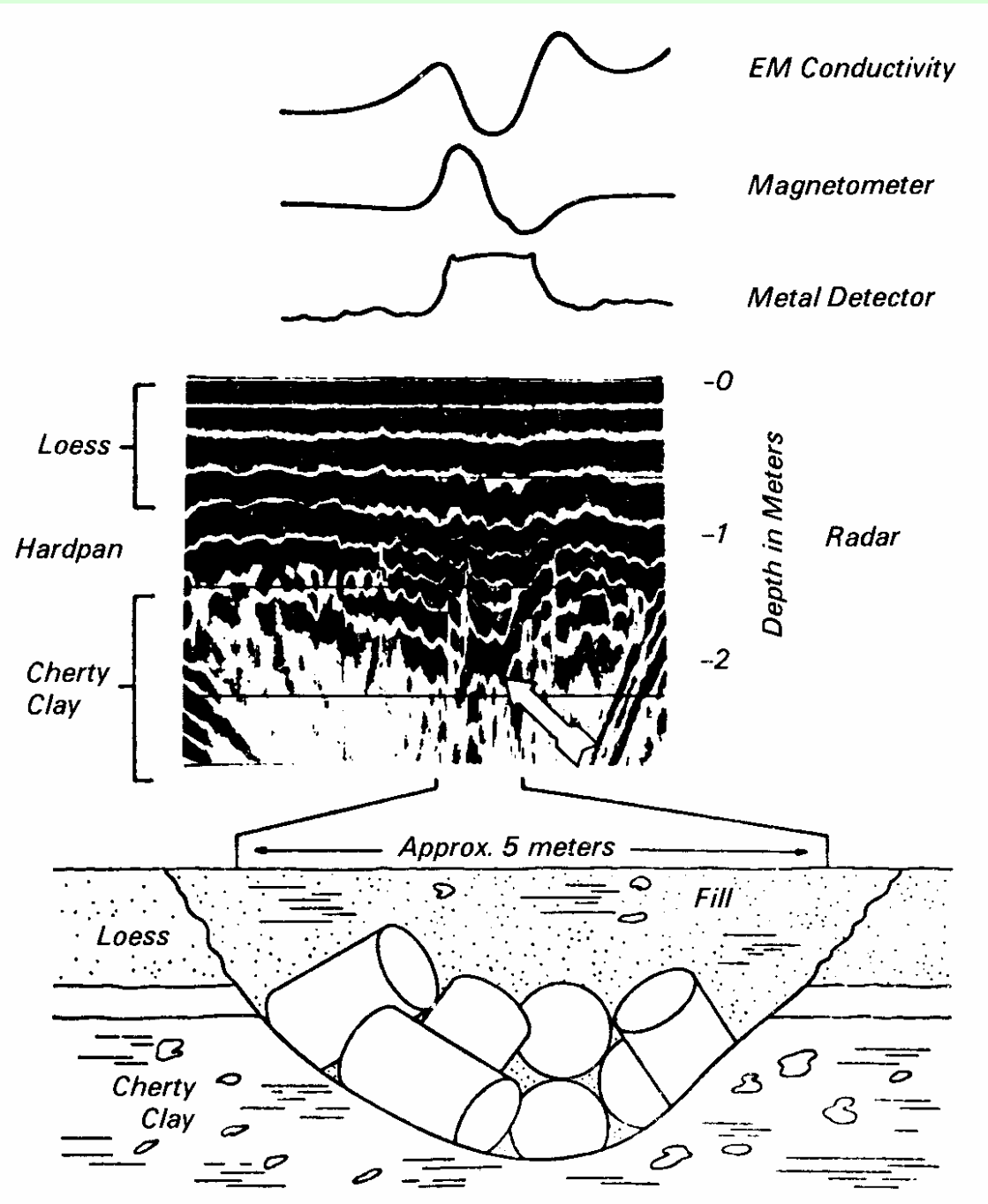

Source: van Ea, J. J., 1985. Project Summary: Geophysical Techniques for Sensing Buried Wastes and Waste Migration. Report Number EPA/600/S7-84/064. Environmental Monitoring Systems Laboratory, U.S. Environmental Protection Agency, Las Vegas, Nevada. May 1985.

# Direct-push technology (Geoprobe)



Source: Environmental Protection Agency, Region 9, Charnock MTBE Cleanup Project.  
[http://www.epa.gov/region09/cross\\_pr/mtbe/charnock/site23.html](http://www.epa.gov/region09/cross_pr/mtbe/charnock/site23.html). Accessed May 11, 2004.

# Direct-push monitoring well

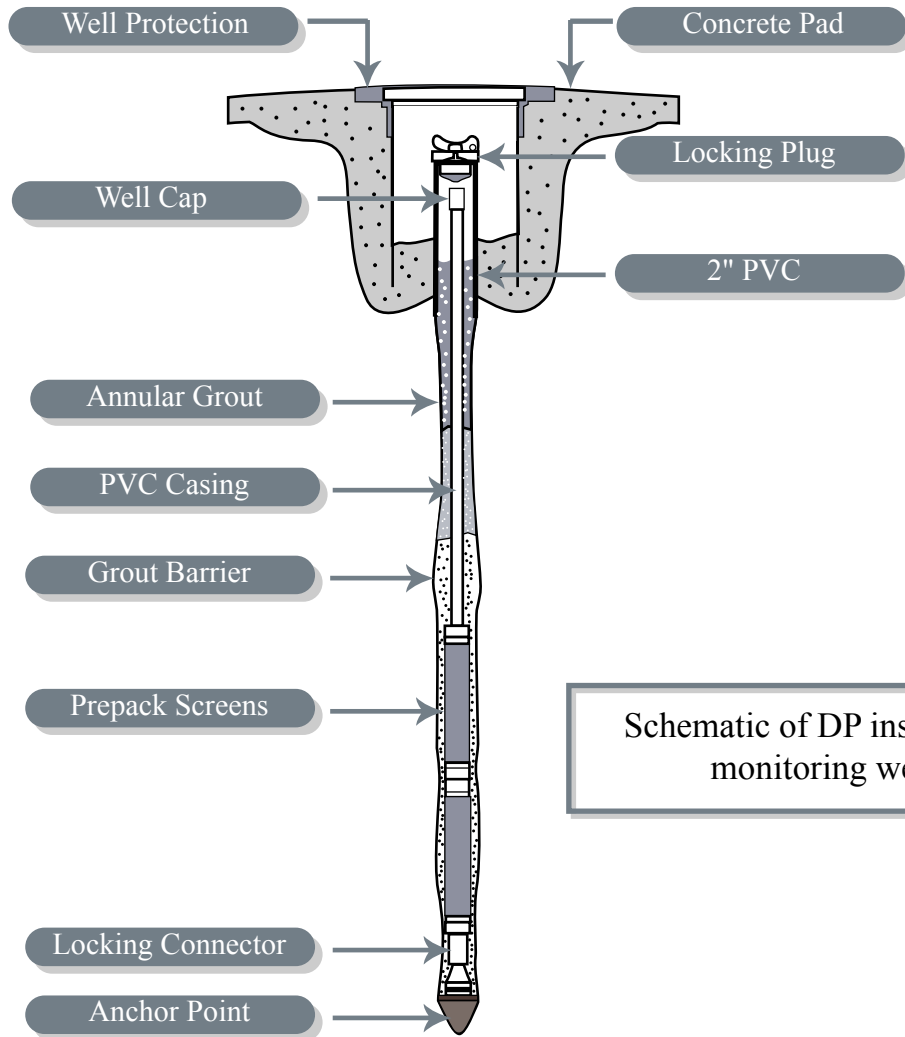

Schematic of DP installed small diameter monitoring well construction.

Adapted from: McCall, W. "Getting a Direct Push." *Environmental Protection* 13, no. 7 (September 2002): 49-53.

# Drilling techniques

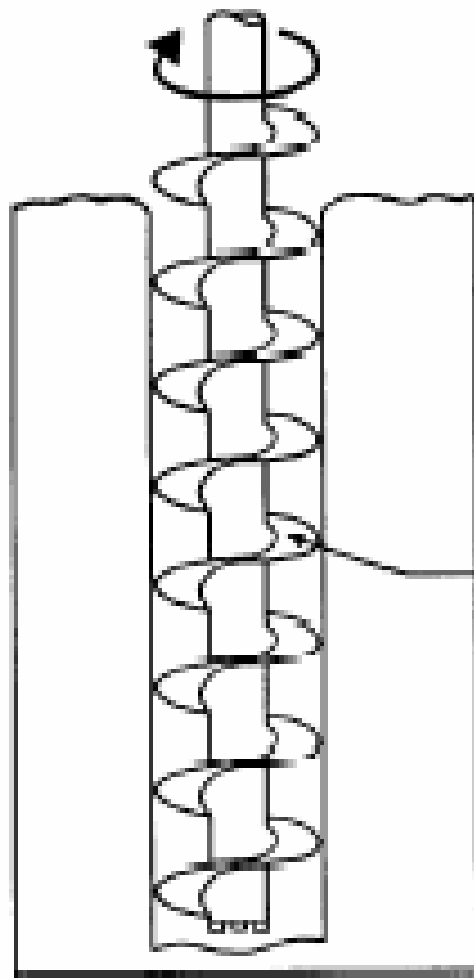

Auger flight

Hollow-stem auger

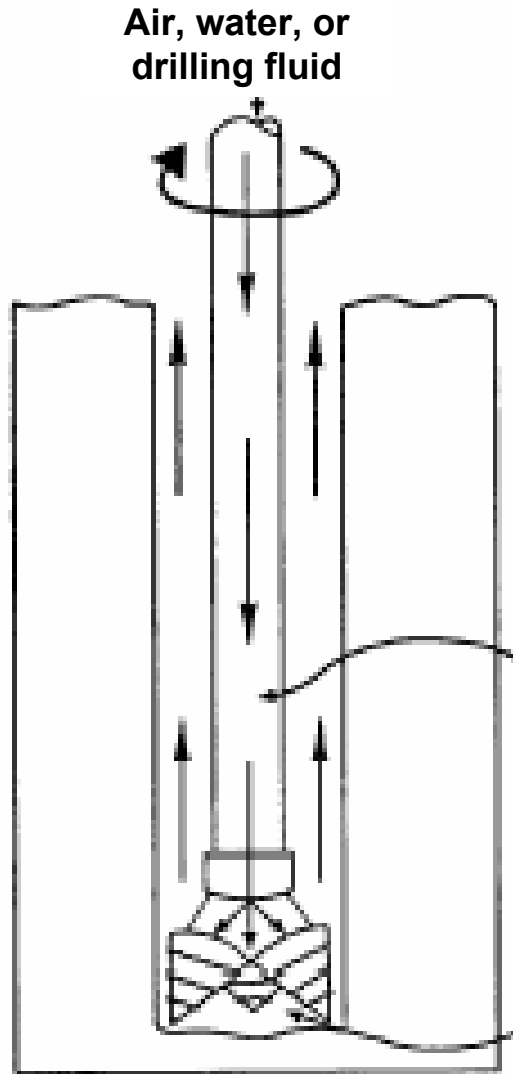

Direct rotary

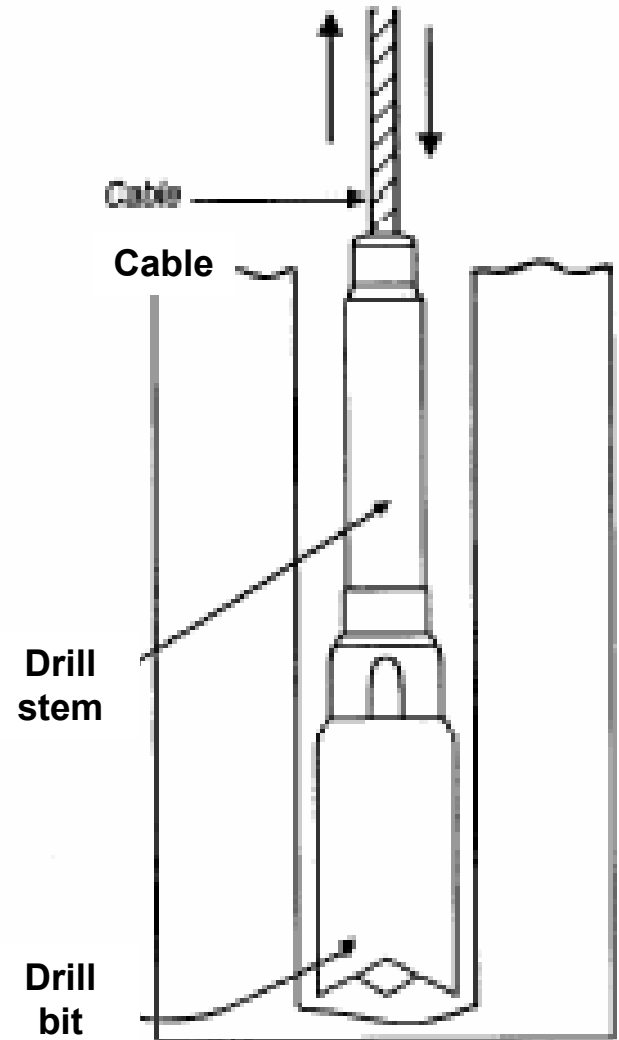

Cable tool

Note: hollow-stem augering can cause smearing of well wall.  
Cable-tool also called percussion drilling. Drive-and-wash is similar, but circulates water to wash cuttings out of hole.  
Also Barber rig: spins in a pipe fitted with cutting bits.  
Ultrasonic and vibratory – vibrates casing into soft formations.



# Hollow Stem Auger



Source: Environmental Protection Agency, Underground Storage Tanks Office.  
<http://www.epa.gov/swrust1/graphics/miscpix1.htm>. Accessed May 11, 2004.

## Dual-rotary drilling technique

(Dual-rotary  
or  
Barber rig)

See images of the dual-rotary drilling technique at the Web site of Hanjin Drilling Company Ltd.:

[http://www.hjdrilling.com/dual\\_rotary\\_drill.htm](http://www.hjdrilling.com/dual_rotary_drill.htm)

and the Web site of Foremost Industries L.P.:

<http://www.foremost.ca/gallery/dr/dr12w01.jpg>

(Accessed May 11, 2004.)



# Sonic drilling

The drill stem and sampler barrel are vibrated vertically at frequencies between about 50 and 180 Hz such that the sampler barrel normally advances by slicing through the soil.



# Truck-mounted drill rig

Note safety concerns in drilling:

- Overhead power lines

- Buried utility lines

- Dangerous equipment



# Core barrel sampler



Source: M.L. Beutner, August 1988, U.S. Geological Survey, [http://nevada.usgs.gov/adrs/pg\\_soil7.html](http://nevada.usgs.gov/adrs/pg_soil7.html). Accessed May 11, 2004.



# Split-spoon sampler and sample cores



Source: Nevada Division of Environmental Protection, Nellis Air Force Base site, <http://ndep.nv.gov/boff/nellis02.htm>. Accessed May 11, 2004.

# Issues in Field Sampling

Safety

DIG-SAFE

Cross contamination

Artifacts

QA/QC

Field Screening

Sampling Handling

# Potential Artifacts

Methylene chloride, MEK, chloroform, carbon tet.	Laboratory solvents
Phthalates	Plasticizers in tubing
Trihalomethanes (chloroform)	Domestic water
Acetone, isopropyl alcohol, hexane	Field decontaminants
Barium, high pH	Drilling fluid, grout
Carbon disulfide, methyl chloride	Natural chemicals
MEK	Duct tape

# Components of monitoring well

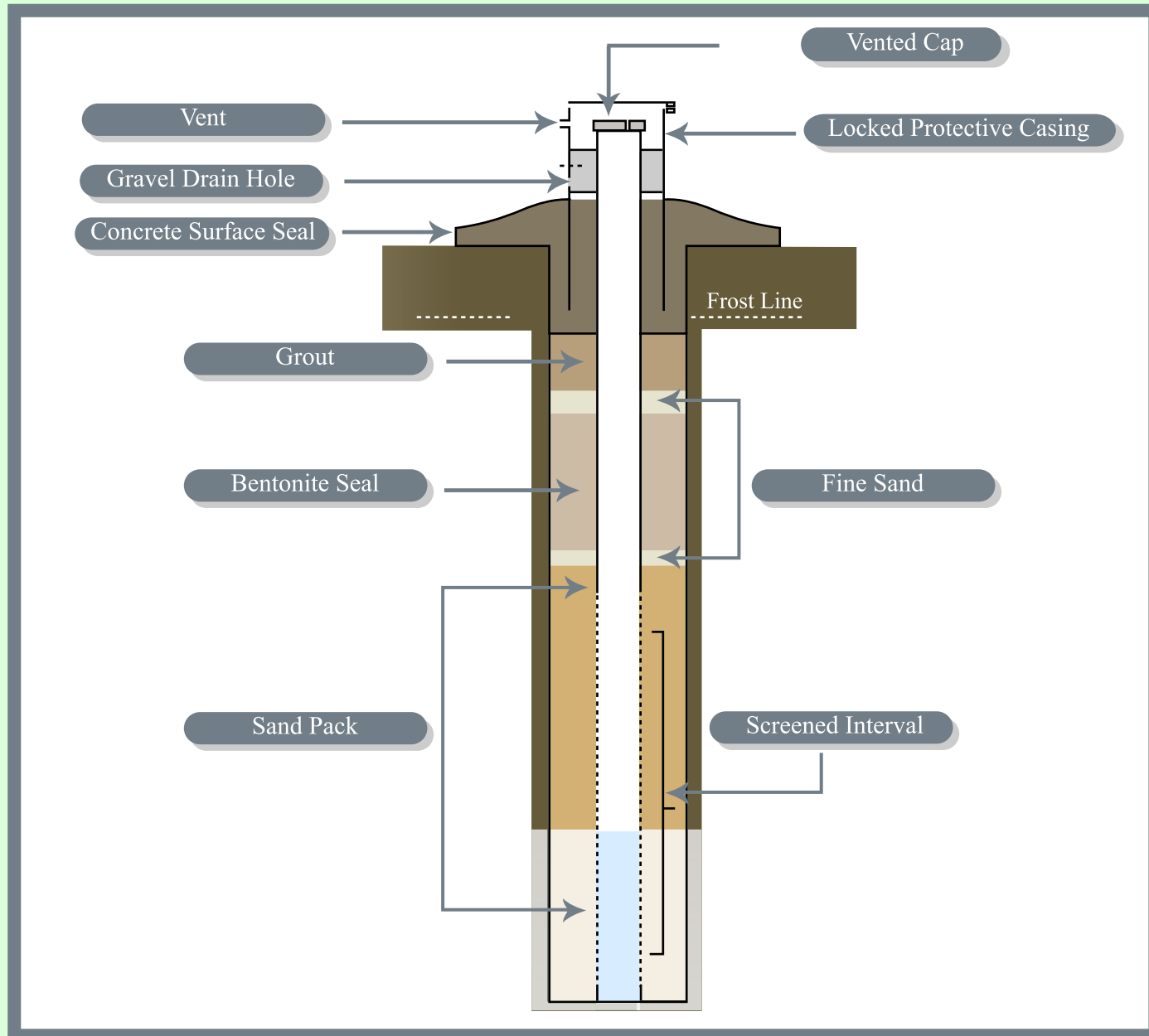

1. Drill and log borehole.

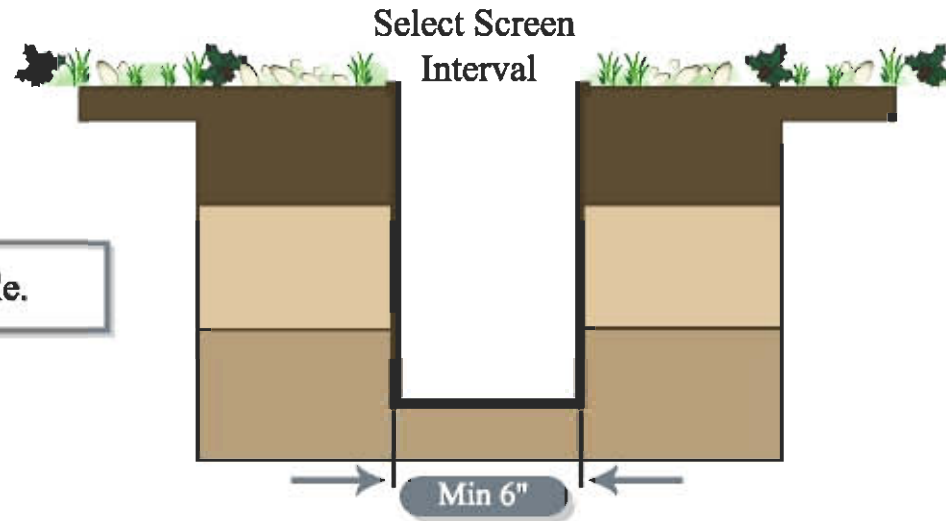

2. Construct well casing and center in the borehole.

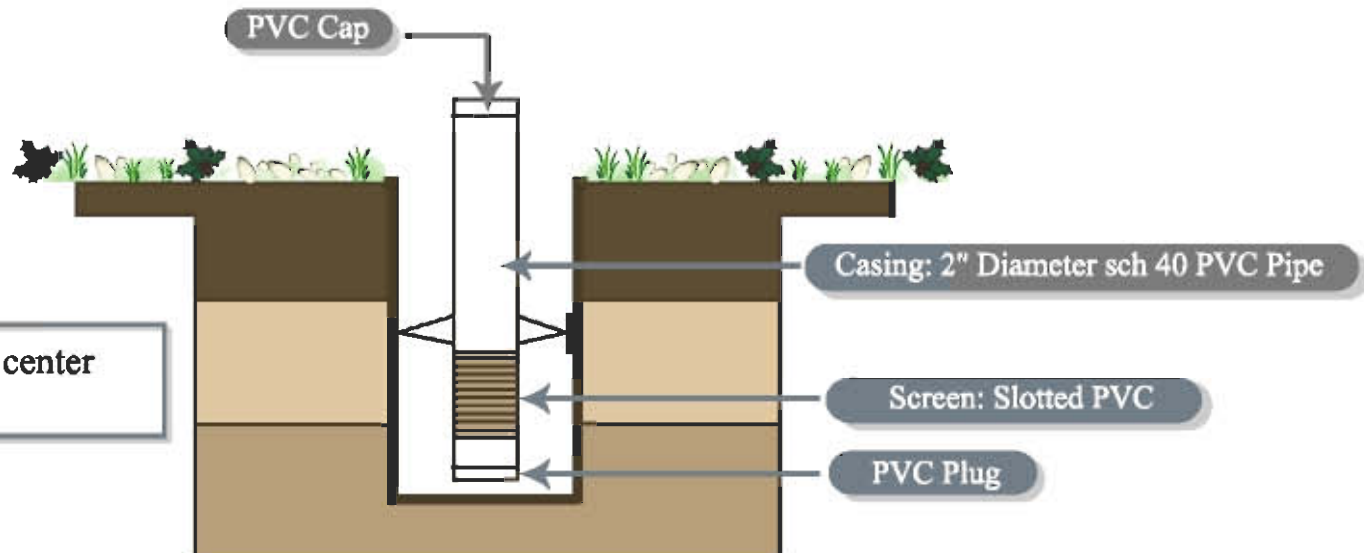



**3. Install clean, coarse backfill to 1 ft. height above top of screen.**

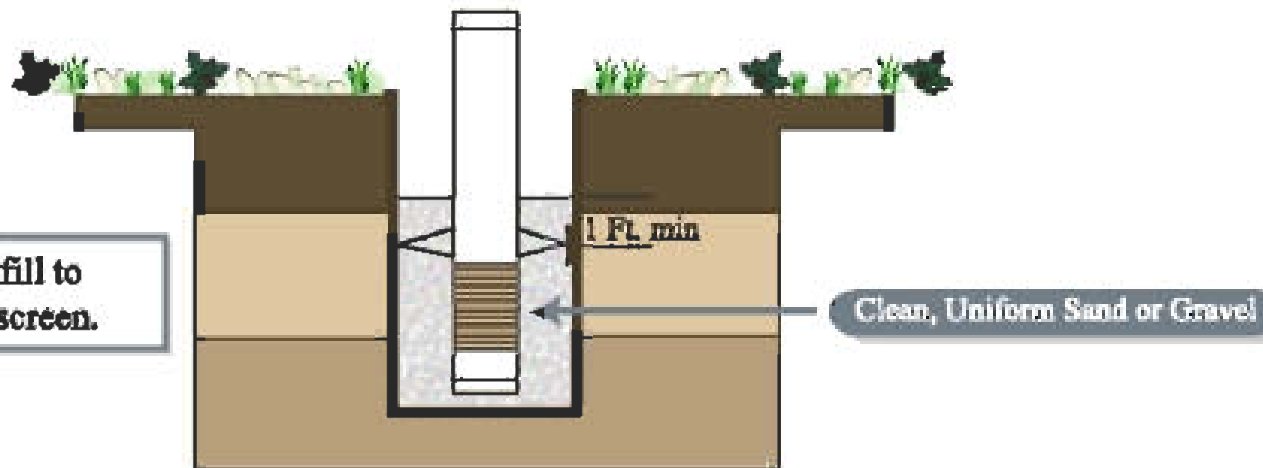

**4. Add bentonite seal. Grout to surface pad. Wait 24 hr to develop.**

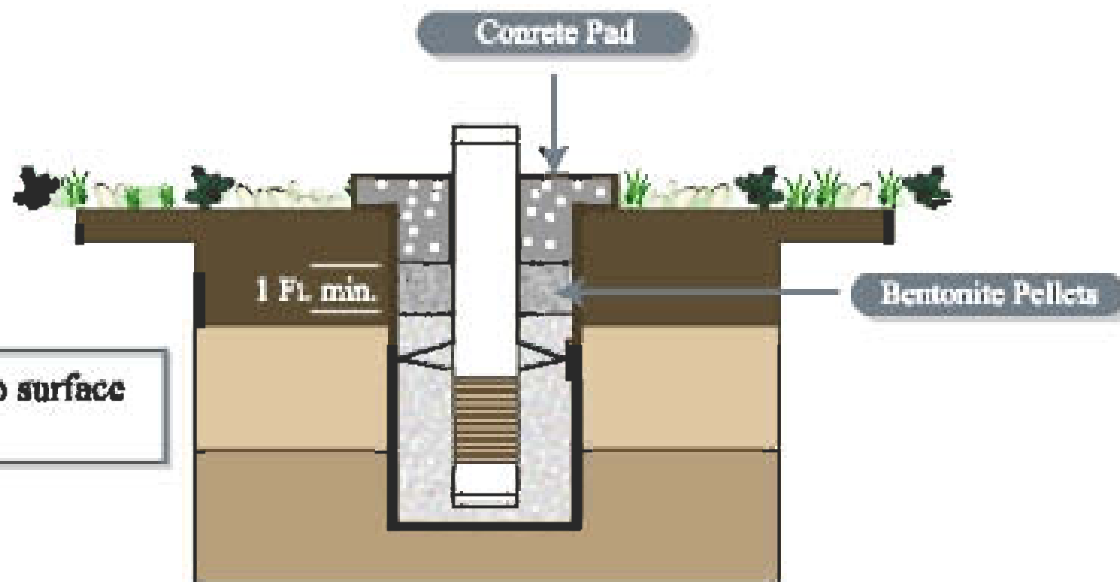

# Well development by surge block

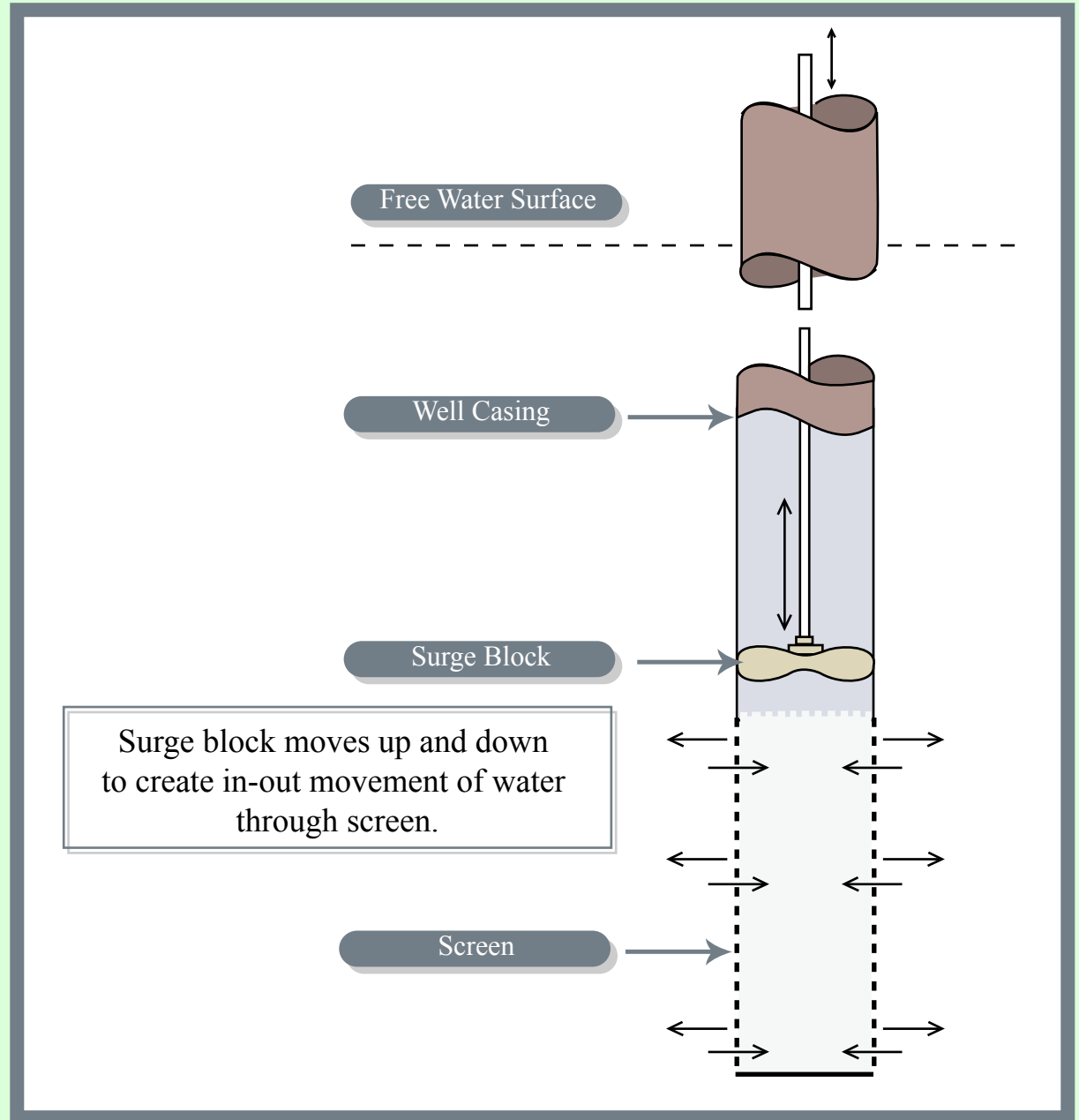

# Surge block

See image at the Web site of Robertson GeoConsultants, Inc., RGC Image Library, Technology Themes, Hydrogeology and Hydrology:

[http://www.robertsongeoconsultants.com/RGC\\_Images/pages/RGC\\_Technical\\_ThemesHydrogeologyHYFU\\_rgc027101.asp](http://www.robertsongeoconsultants.com/RGC_Images/pages/RGC_Technical_ThemesHydrogeologyHYFU_rgc027101.asp) .

Accessed May 11, 2004.

# Well Logs

WELL LOG			
FORM NO.: 22	PROJ. NO.: 9470-61139		
PRINCIPAL INVESTIGATOR: E.A. Shinn		TITLE: <b>Subsurface pathways for pollutant transport</b>	
COMPANY: <b>U.S. GEOLOGICAL SURVEY</b>		LOCATION: PLACE - Key Largo Inland #1B (KLI-1B)	DATE BEGAN - 12-21-92
TOTAL DEPTH: 20 feet		DATE FINISHED - 12-21-92	GPS : LAT. - 25°05'51 N
ELEVATION: +5 feet		LONG. - 80°26'18 W	
DRILLING SYSTEM: <b>NX WIRELINE SYSTEM HYDRAULIC ROTARY DRILL</b>			REMARKS:
LOGGED BY: Christopher Reich		DATE: 4-16-93	
PLOTTED BY: Christopher Reich		DATE: 4-16-93	

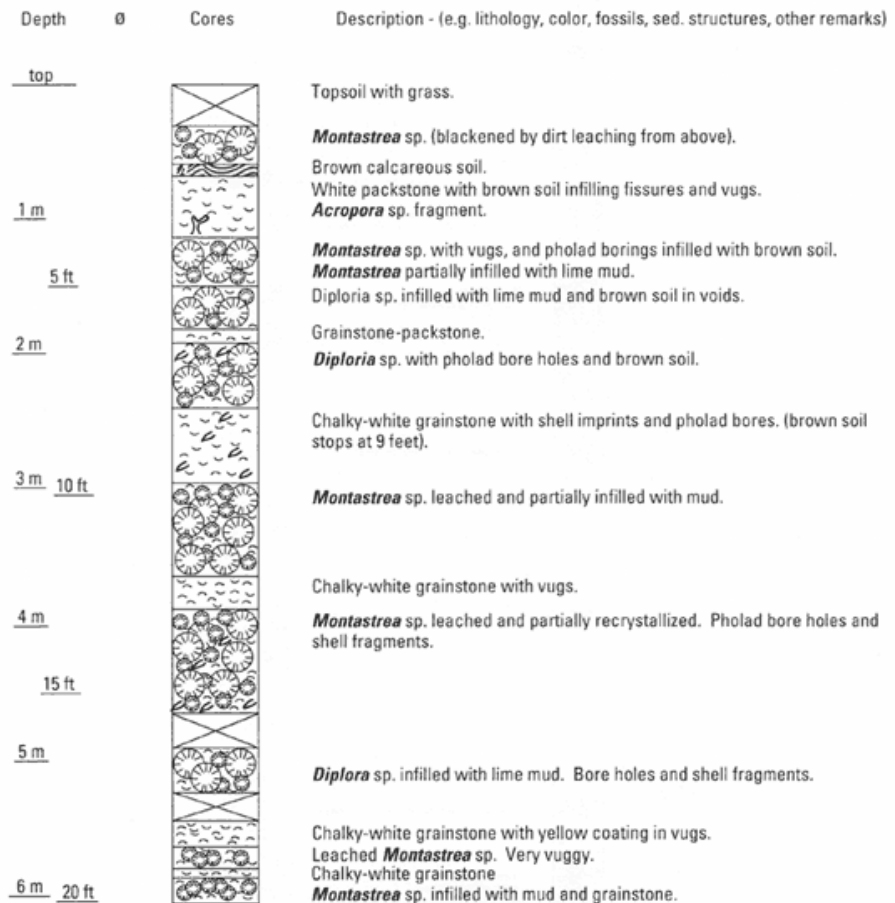

Source: Shinn, E., R. Reese, and C. Reich. "Fate and Pathways of Injection-Well Effluent in the Florida Keys." US Geological Survey Report OFR 94-276. <http://sofia.usgs.gov/publications/ofr/94-276/appendixb.html>. Accessed May 11, 2004.

# Well installation Diagram ("Well cartoon")

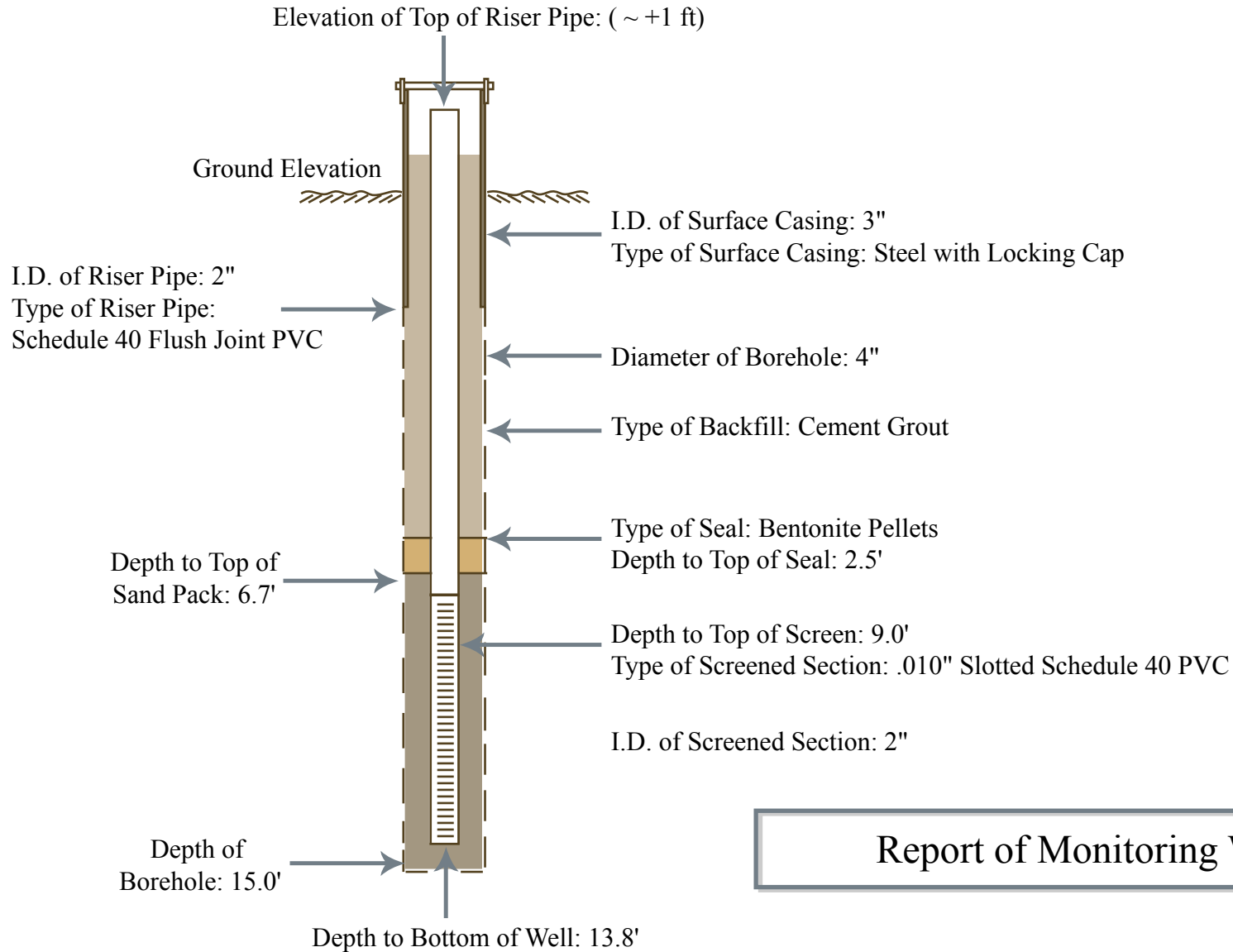

Report of Monitoring Well

# Driller's Log

March 5, 1945

John J. Riley Co.  
228 Salem Street  
Woburn, MA.

Gentlemen:

We are submitting herewith a log of test and observation wells as driven by us recently on your property near your present pumphouse.

Test Well #1

0 - 2'      Loam  
2' - 15'     Brown medium sand  
15' - 20'    Gray fine sand to rock  
              Tight - did not pump freely.

Test Well #2

{ 0 - 3'      Mud and loam  
  3' - 18'    Medium sand and gravel  
  18' - 23'   Coarse gravel  
  23' - 38'   Sand and gravel to rock  
              Pumped free - 60 G.P.M.  
              Observation Well at 37'  
              This well tested for both capacity  
              and drawdown.

It is in our opinion that at location #2 we could develop you, with one of our large diameter gravel filter wells, 500 G.P.M. with a safe drawdown and would run a preliminary test on this well at the above rated capacity for a period of forty-eight hours to determine the actual drawdown on this well.



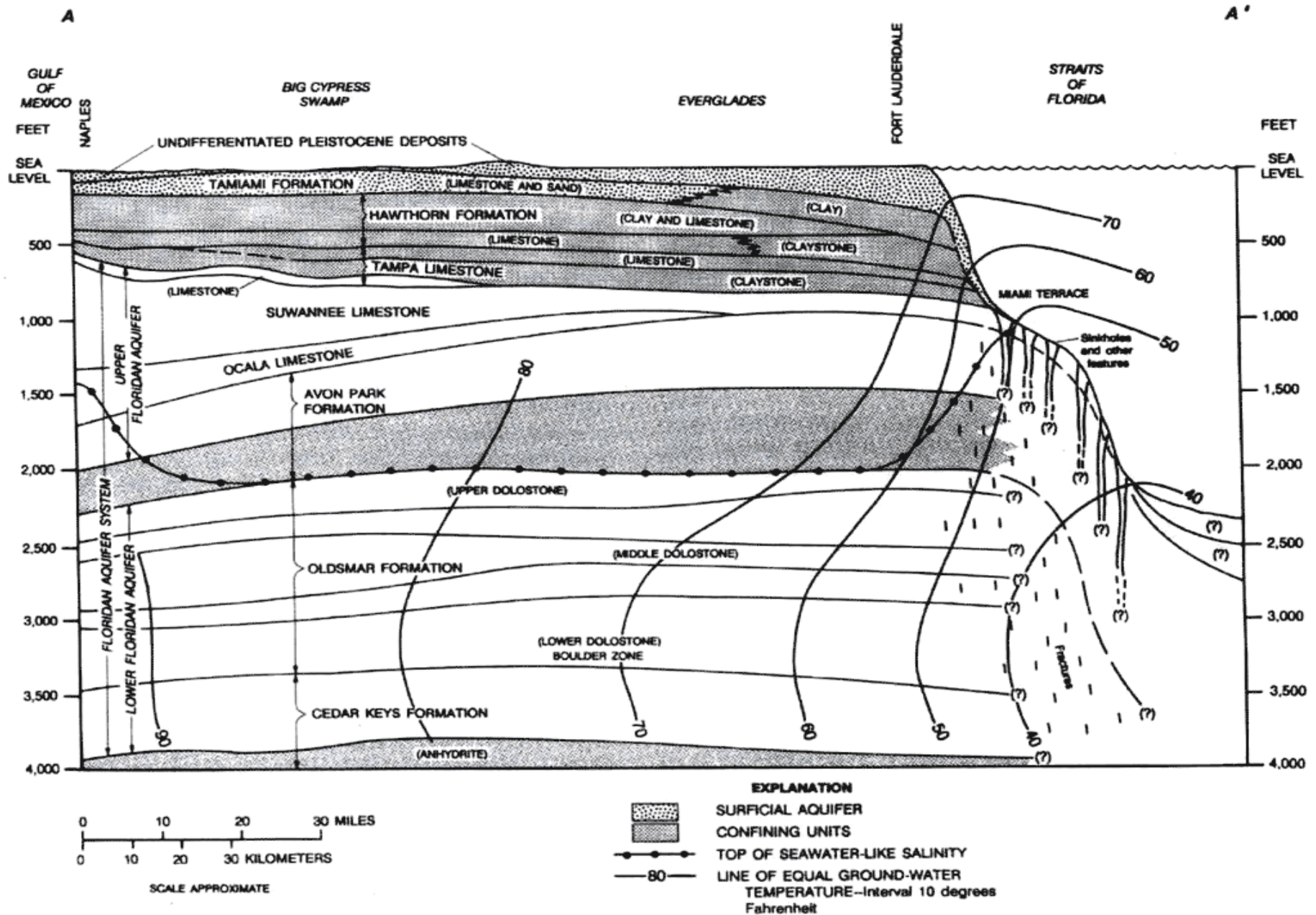

Source: Meyer, F.W. "Hydrogeology of Southern Florida: Floridan Aquifer System." US Geological Survey, <http://sofia.usgs.gov/publications/papers/pp1403g/flaqsys.html>. Accessed May 11, 2004.



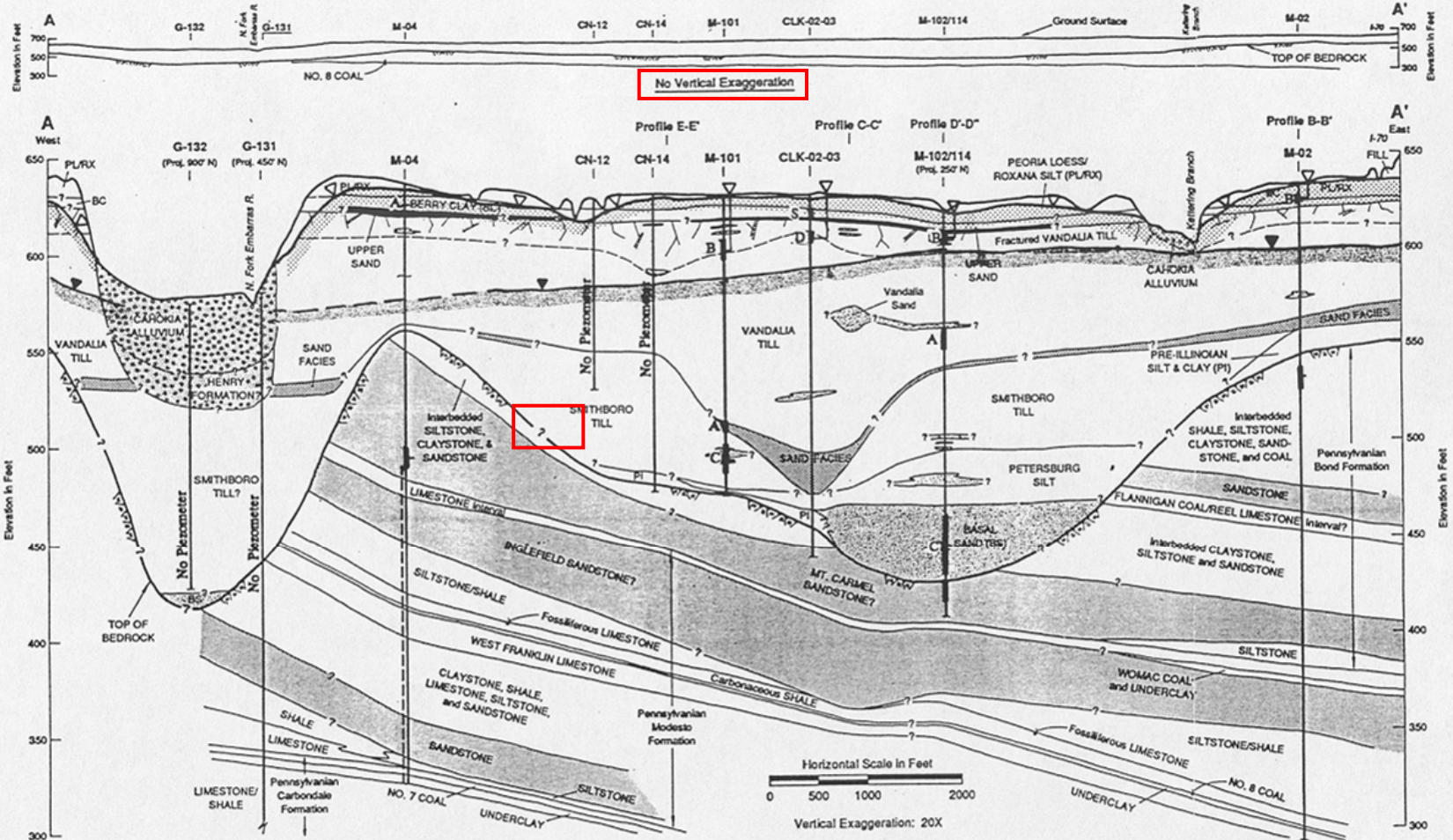

**EXPLANATION**

Potentiometric Surface of Surficial Water-Bearing Zone

Potentiometric Surface of Sand Facies

Screen Suffix Letter (if used)

Water Level, February 1990

Piezometer Screen

Sand-Filled Core Hole

**NOTES**

Descriptions of geologic units are presented on Figures 4-2, 4-4, and 4-5 in Vol. II.

Water-Level Locations taken from Figure 4-21.

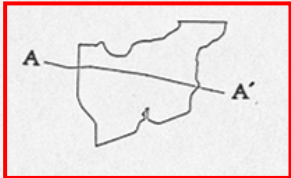

Hydrogeology Section A-A'

Figure 4-6

This is a good example of a well-done cross section, particularly for its inclusion of an unexaggerated profile along with the exaggerated.

# Martinsville Alternative Site Hydrostratigraphy

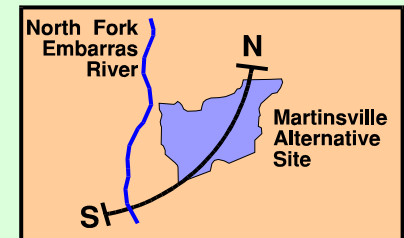
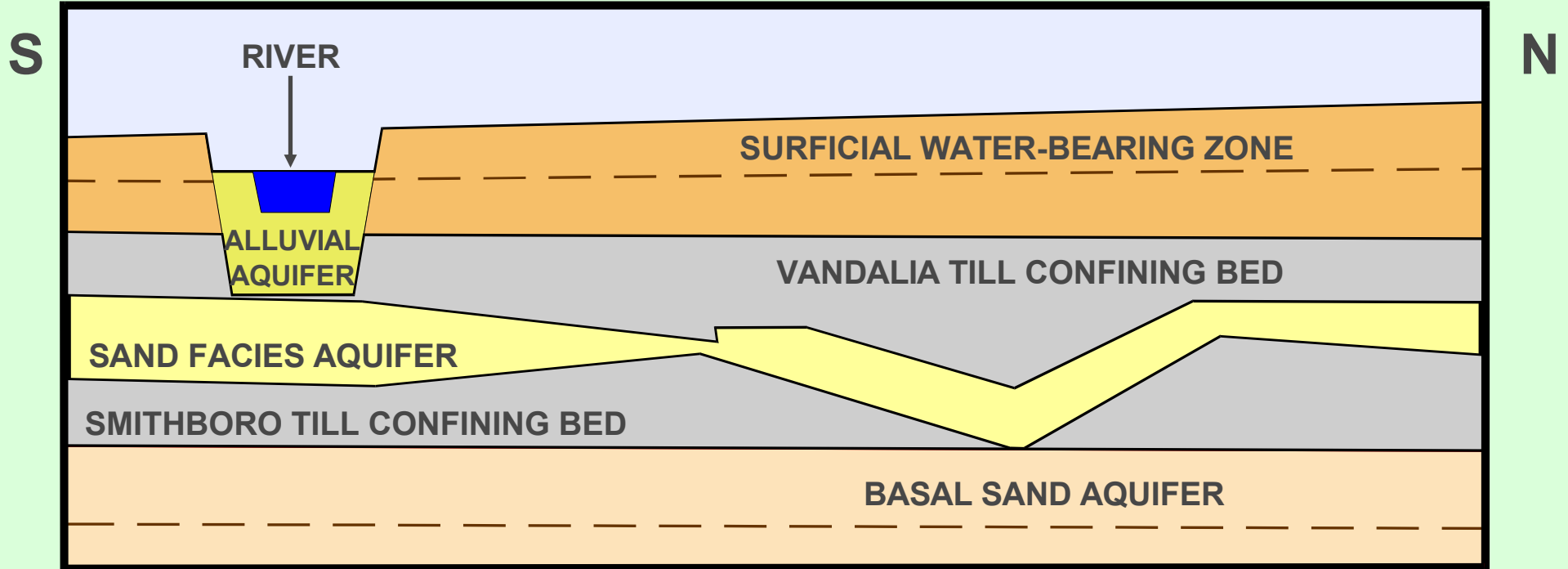



# Well construction

Flush-mounted well



Source: Johnson Creek Basin Monitoring, US Geological Survey, [http://oregon.usgs.gov/projs\\_dir/or175/htmls\\_dir/holgate.html](http://oregon.usgs.gov/projs_dir/or175/htmls_dir/holgate.html). Accessed May 11, 2004.

“Stick-up” well and protective cover



Source: Acadian Pontchartrain (ACAD) Groundwater Studies, US Geological Survey, <http://la.water.usgs.gov/nawqa/liaison/gwgeneral.htm>. Accessed May 11, 2004.

# Water-level meter

See images at the Web site of Solinst Canada Ltd. <http://www.solinst.com/Prod/101/101an.html>  
Accessed May 11, 2004.

# Bailer for sample collection from wells

See images at the Web site of Solinst Canada Ltd. <http://www.solinst.com/Prod/428/428.html>  
Accessed May 11, 2004.



# Collection of volatile organics samples



Source: Berndt, M.P., Hatzell, H.H., Crandall, C.A., Turtora, M., Pittman, J.R., and Oaksford, E.T., 1998, "Water Quality in the Georgia-Florida Coastal Plain, Georgia and Florida, 1992-96: U.S. Geological Survey Circular 1151", <http://water.usgs.gov/pubs/circ/circ1151/nawqa91.2.html>. Accessed May 11, 2004.

# Soil sample collection

Stainless steel  
sampling trowel



Source: Region 10 Superfund: Boomsnub/AIRCO site, US Environmental Protection Agency, <http://yosemite.epa.gov/R10/CLEANUP.NSF/0/d4f7133deabb8eea88256a1700634f74?OpenDocument>. Accessed May 11, 2004.

# Drum Thief or Coliwasa

See image at the Web site of GENEQ Inc.

[http://www.geneq.com/catalog/en/coliwasa\\_liquid\\_waste.html](http://www.geneq.com/catalog/en/coliwasa_liquid_waste.html)

Accessed May 11, 2004.



### CHAIN OF CUSTODY RECORD

PROJ. NO.		PROJECT NAME				NO. OF CON- TAINERS	ANALYSIS						REMARKS
SAMPLERS: (Signature)													
STA. NO.	DATE	TIME	COMP	GRAB	STATION LOCATION								
Relinquished by: (Signature)			Date / Time		Received by: (Signature)			Date / Time		Received by: (Signature)			
Relinquished by: (Signature)			Date / Time		Received by: (Signature)			Date / Time		Received by: (Signature)			
Relinquished by: (Signature)			Date / Time		Received for Laboratory by: (Signature)			Date / Time		Remarks			

Distribution: Original Accompanying Shipment; Copy to Coordinator; Field File

Source: "Evaluation of Dredged Material Proposed for Discharge in Waters of the U.S. -- Testing Manual," US Environmental Protection Agency, <http://www.epa.gov/waterscience/itm/ITM/appxg.htm>. Accessed May 11, 2004.

# Laboratory Analysis

**Full analysis - \$1100**

(volatiles, semivolatiles, RCRA Appendix 8, pesticides, herbicides)

**Volatile organics - \$185**

**Semivolatile organics - \$360**

**RCRA Appendix 8 metals - \$110**

(As, Ba, Cd, Cr, Pb, Hg, Se, Ag)

**TAL metals - \$240**

(Al, Sb, As, Ba, Be, Cd, Ca, Cr, Co, Cu, Fe, Pb, Mg, Mn, Hg, Ni, K, Se, Ag, Na, Tl, V, Zn)

**Pesticides - \$145**

**Herbicides - \$250**

# Peristaltic (suction-lift) pump

See images at the Web site of the Georgia Tech course on Environmental Field Methods:  
<http://hydrate.eas.gatech.edu/eas4420/water.htm>  
Accessed May 11, 2004.

Maximum sampling depth  $\approx$  25 feet  $\approx$  8 meters

# Submersible Pump

See images at the Web site of Noor Scientific and Trade. [http://www.noor-scientific.com/survey\\_groundwater\\_instruments.htm](http://www.noor-scientific.com/survey_groundwater_instruments.htm). Accessed May 11, 2004.

# WaTerra Positive Displacement Pump

See images at the Web site of Noor Scientific and Trade. [http://www.noor-scientific.com/survey\\_groundwater\\_instruments.htm](http://www.noor-scientific.com/survey_groundwater_instruments.htm). Accessed May 11, 2004.

# Bladder Pump

See images at the Web site of Solinst Canada Ltd.

<http://www.solinst.com/Prod/407/407d5.html>. Accessed May 11, 2004.

# Bladder Pump

See images at the Web site of Solinst Canada Ltd.

<http://www.solinst.com/Prod/407/407d5.html>. Accessed May 11, 2004.

# Soil Water Lysimeter

See images at the Web sites of Earth Systems Solutions (<http://www.earthsystemssolutions.com/assets/watersampler.htm>) and the Wisconsin Department of Natural Resources, Vadose Zone Soil-Water Monitoring (<http://www.dnr.state.wi.us/org/water/dwg/gw/dsk-7a.htm>). Accessed May 11, 2004.



# Well purging before sampling

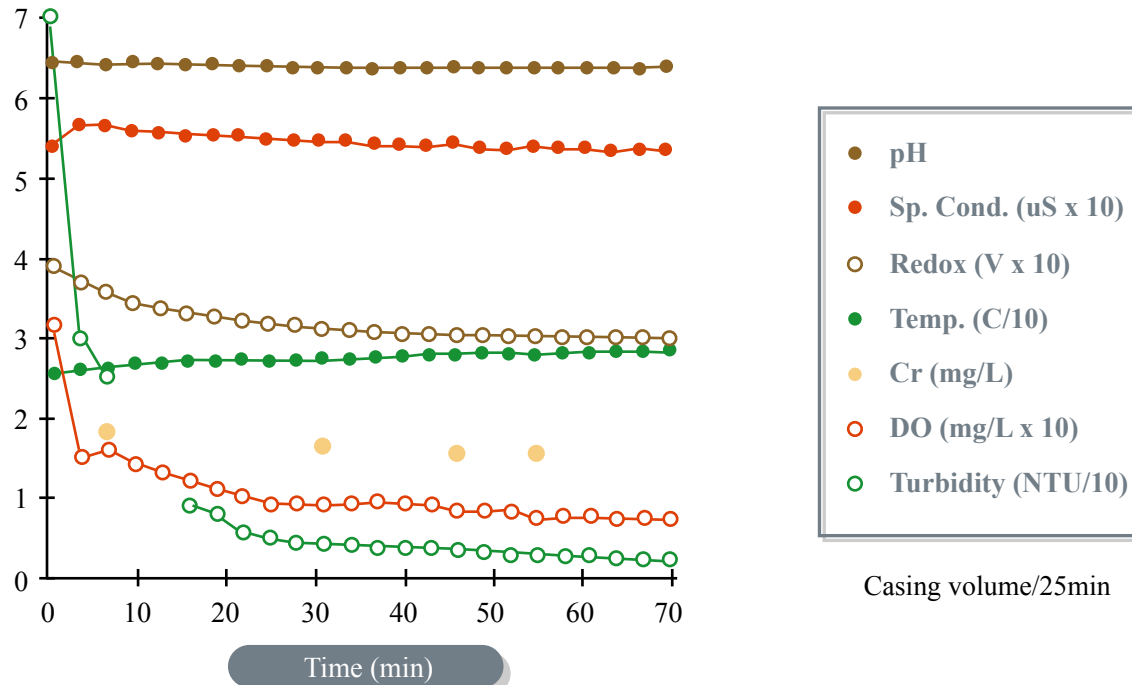

Equilibration of ground water quality indicators during purging and sampling (well 17, Elizabeth City, North Carolina; Grundfos Redi-Flo2 submersible pump, 0.2 L/min).

Adapted from: Puls, R. W. and R. M. Powell. "Acquisition of Representative Ground Water Quality Samples for Metals." *Ground Water Monitoring Review* 12, no. 3 (1992): 167.

# Well purging before sampling

Rule of thumb is to purge 3 to 5 well volumes before sampling

Results from previous slide show stabilization of parameters after around one well volume

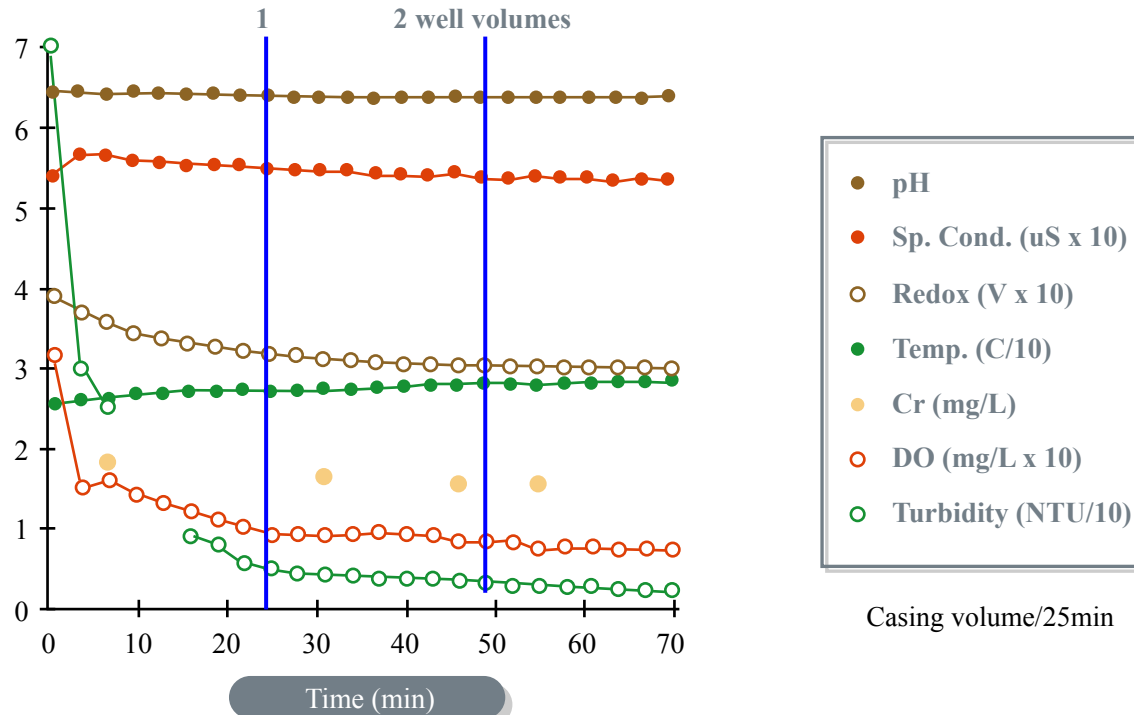

Equilibration of ground water quality indicators during purging and sampling (well 17, Elizabeth City, North Carolina; Grundfos Redi-Flo2 submersible pump, 0.2 L/min).

# “Low-flow” sampling

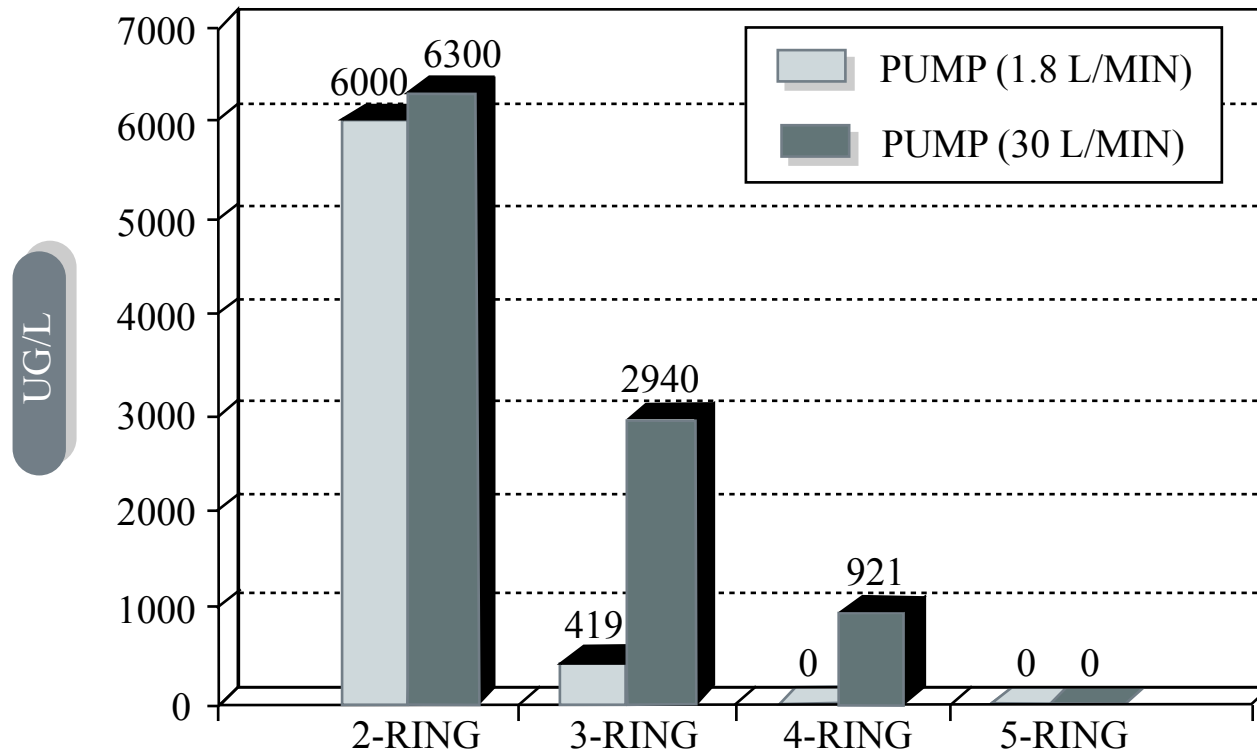

Adapted from: MacFarlane, I. D., J. L. Kocornik, F. T. Barranco, and A. R. Bonas. "The Application of Slow Pumping at a Manufactured Gas Plant." The Sixth National Outdoor Action Conference on Aquifer Restoration. Ground Water Monitoring and Geophysical Methods. Las Vegas, NV: Water Well Journal Publishing Company, 1992.

# Slug test

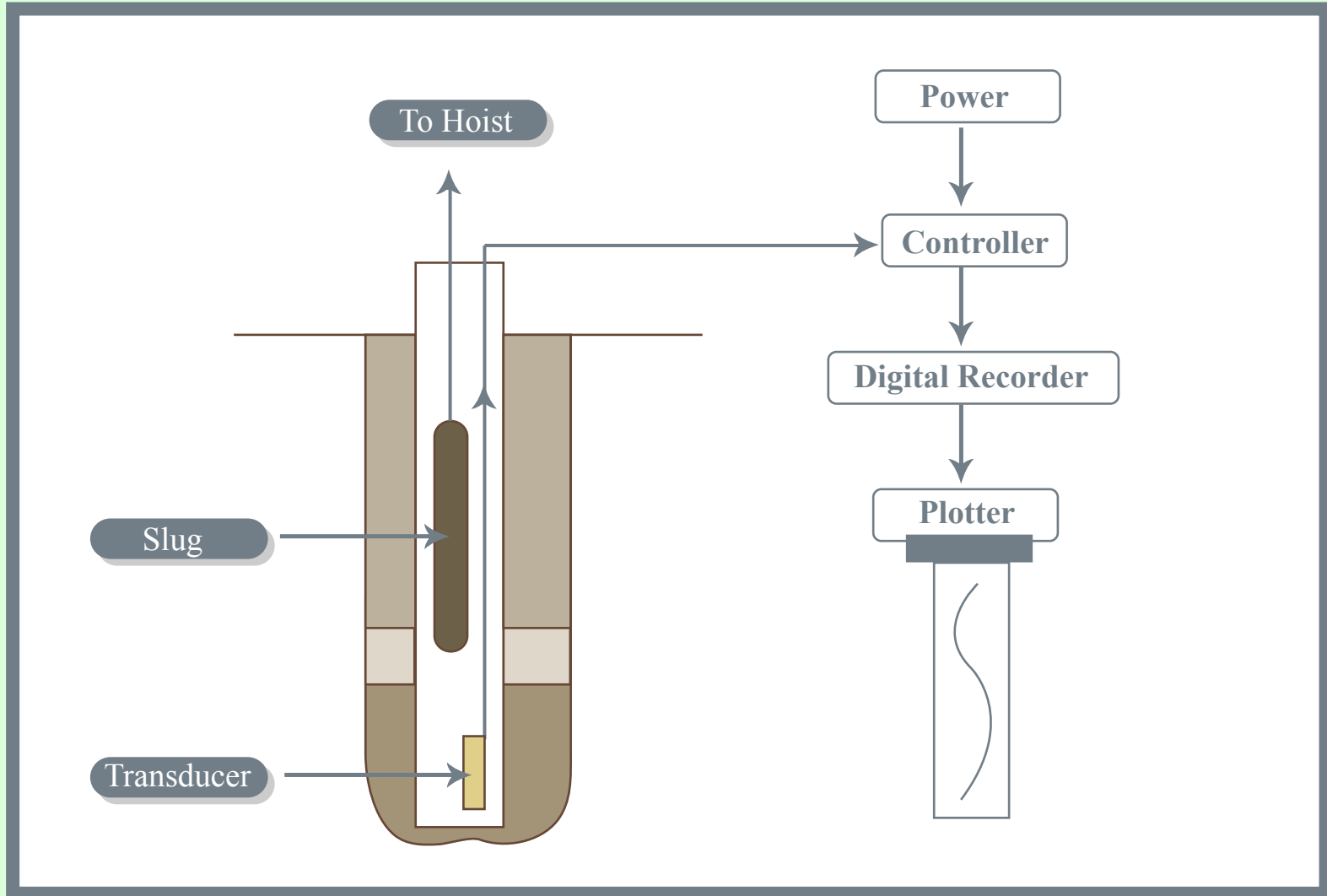

# Slug test results

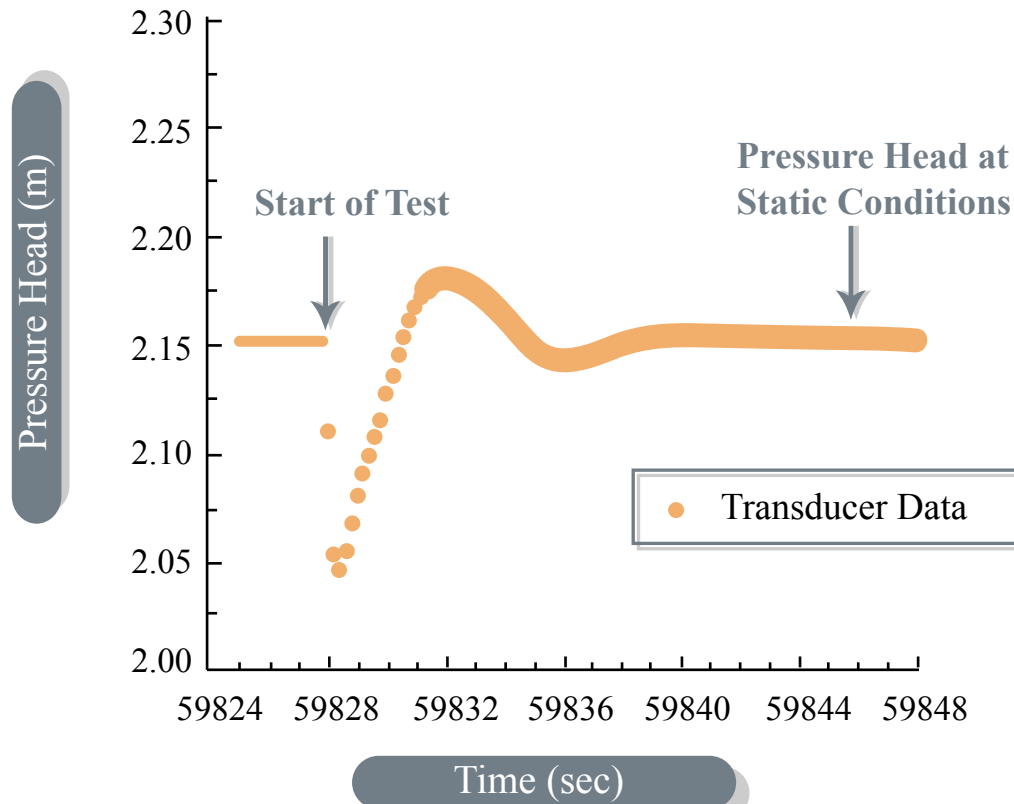

Gems4S - Multilevel Slug Test #5 17.68 m Below TOC - 7/19/99