

Natural Light in Design

Using simulation tools to explore realistic daylight-responsive solutions

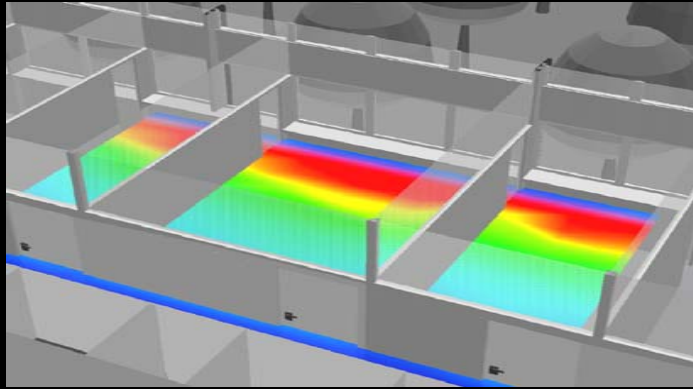

Daylight Factor

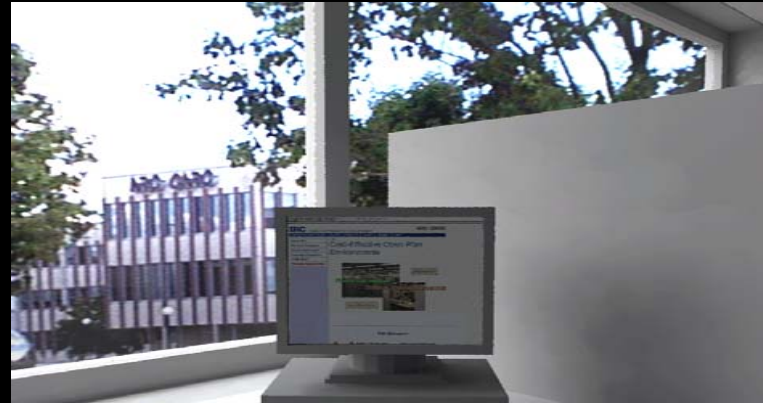

Visual Comfort

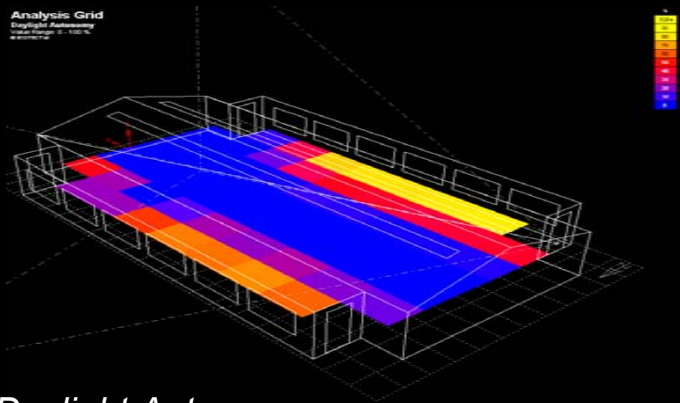

Daylight Autonomy

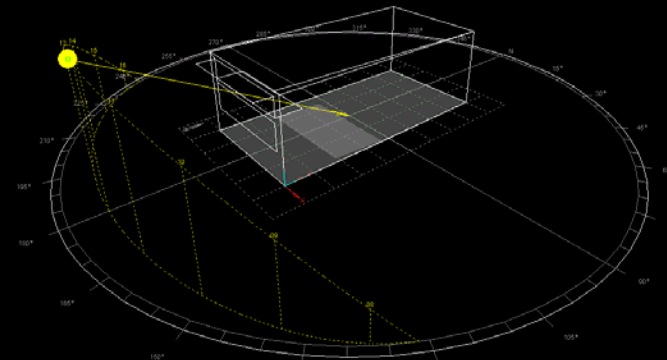

Avoidance of Direct Sunlight

Daysim

Christoph Reinhart, Ph.D.

Overview – Daysim

Tuesday, Jan 24^a 2006

time slot	Content	instructor
Mon 9.30	Welcome, class introduction, design project (teams formed next morning)	MA, all
Mon 10.00	- General Introduction to daylighting (benefits, history, some case studies)	MA
Mon 10.30	- Introduction to Building Simulation (why simulations for architects, tools used in this course)	CR
Mon 11.00	coffee break	
Mon 11.15	<ul style="list-style-type: none"> - Photometry (definition, measurement, typical values, DF definition) (MA) - Static Daylighting Metrics (context of LEED, selected results from NRC survey, DF & Solar Shading) (CR) - Daylight factor calculations: protractor method, LEED spreadsheet method, sky models CIE and Perez (MA) - Daylight factor simulation: design sky, split flux method in Ecotect (CR) <ul style="list-style-type: none"> ▪ Hands-on exercise: DF calculation in Ecotect (split flux) (CR) ▪ Hands-on exercise: solar shading module in Ecotect (CR) - Intro to Radiance (CR) <ul style="list-style-type: none"> ▪ Hands-on exercise: Radiance visualizations (CR) ▪ Hands-on exercise: DF calculation in Ecotect (Radiance) (CR) 	MA, CR, all
Mon 13.00	lunch (on your own)	
Mon 14.00	<ul style="list-style-type: none"> - Climate Data (kind of data and measurement, weather files, E+ weather data directory) (MA) <ul style="list-style-type: none"> ▪ Hands-on exercise: weather tool in Ecotect (CR) - Overview on visual comfort (glare, contrast, requirements, health) (MA) - Dynamic Metrics & related tools (CR) 	MA, CR, all
Mon 15.45	coffee break	
Mon 16.00	<ul style="list-style-type: none"> ▪ Hands-on exercise: Daysim exercise from tutorial interrupted by discussions on: <ul style="list-style-type: none"> - Short time steps dynamics - Daylight Coefficients - User Behavior Model - Daylight Autonomy Results 	all
Mon 17.00	<ul style="list-style-type: none"> ▪ Hands-on exercise: students to repeat at DF, Solar Shading & DA analysis on their own 	all
Mon 17.30	end of first day	

Required Work Flow

SketchUp/ AutoCAD/ Ecotect/ ...

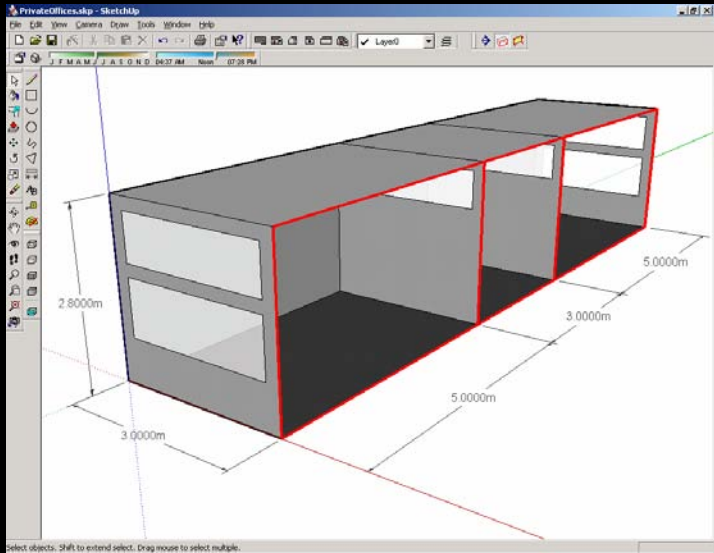

Daysim Analysis www.daysim.com

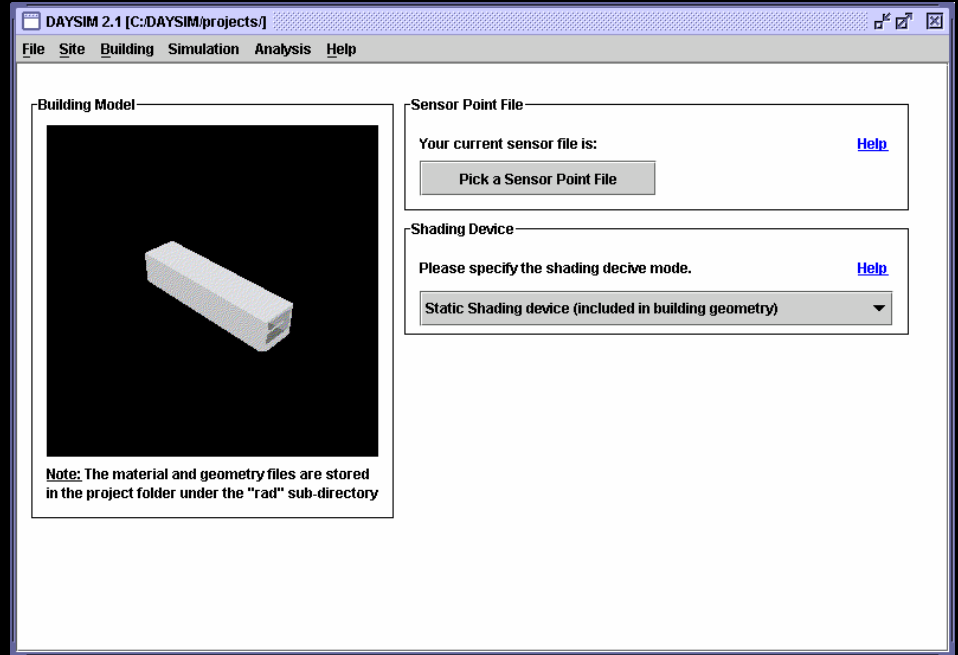

Daysim Simulation Report

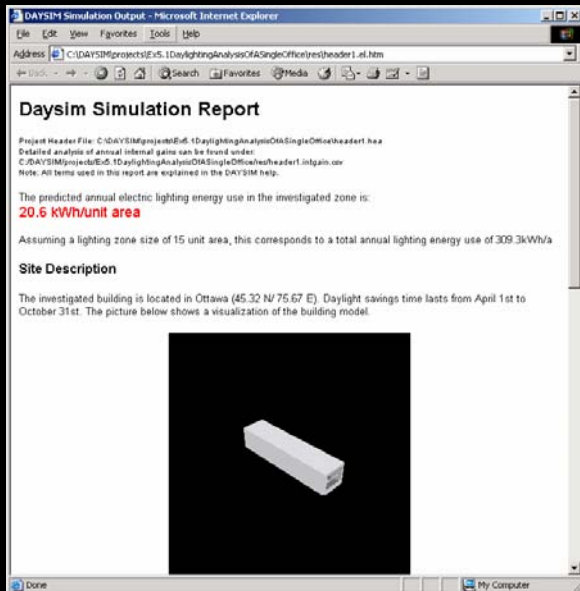

falsecolor maps

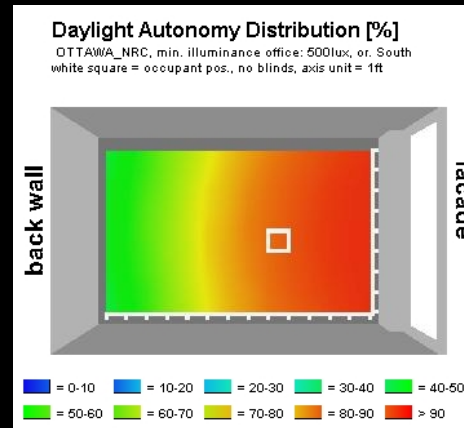

Daysim Statistics

number of individuals who downloaded DAYSIM

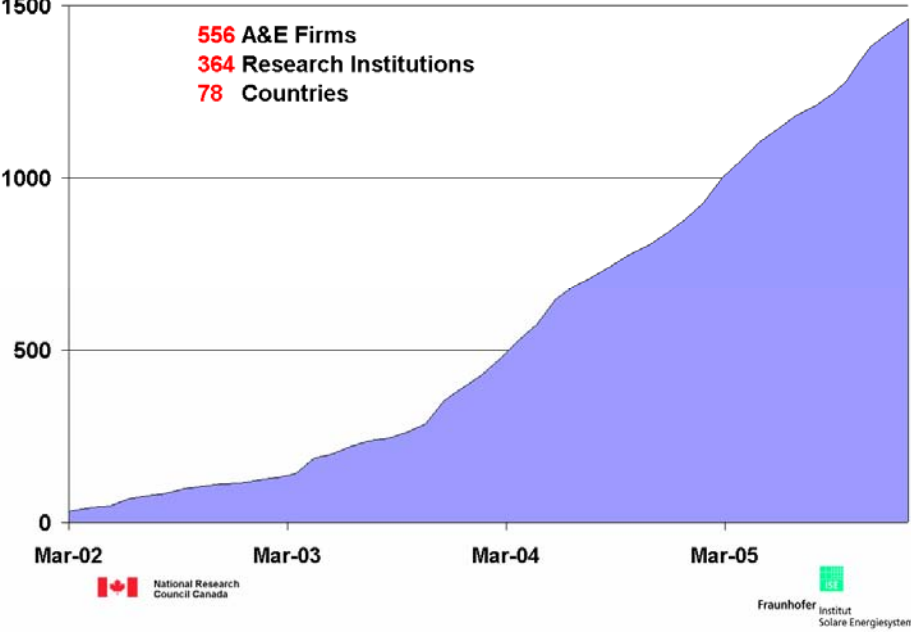

Downloads by Country

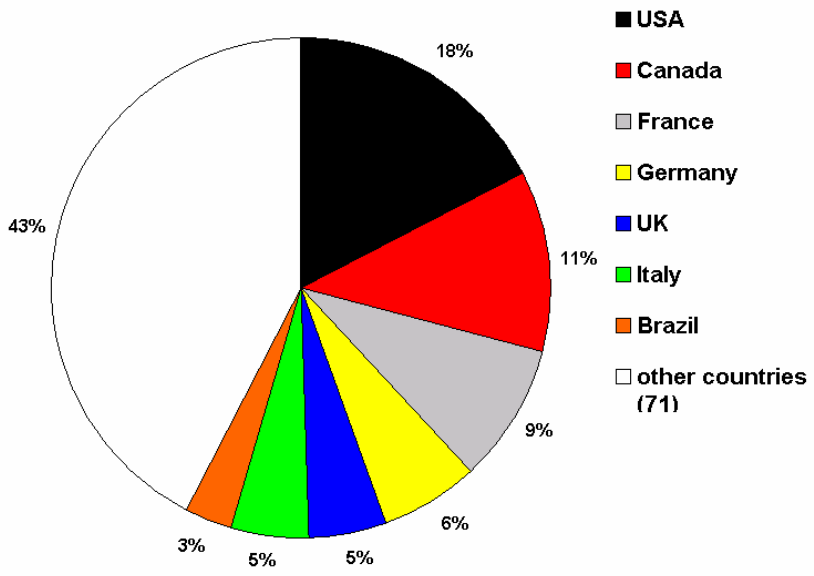

www.daysim.com

Example I – Single office

office building

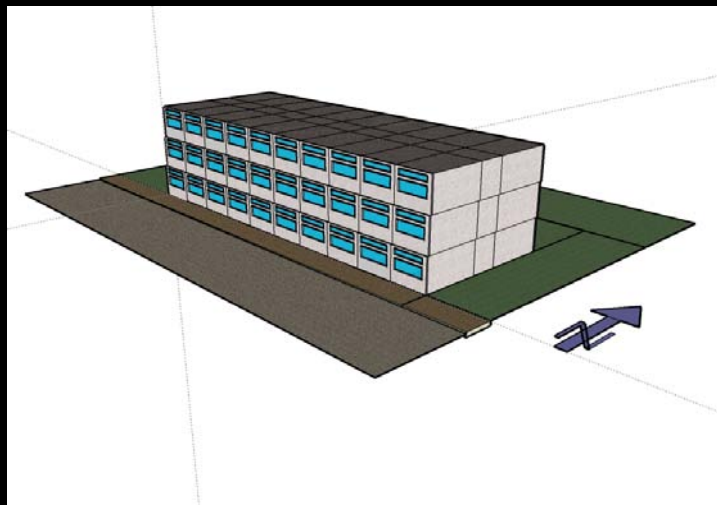

three lighting zones

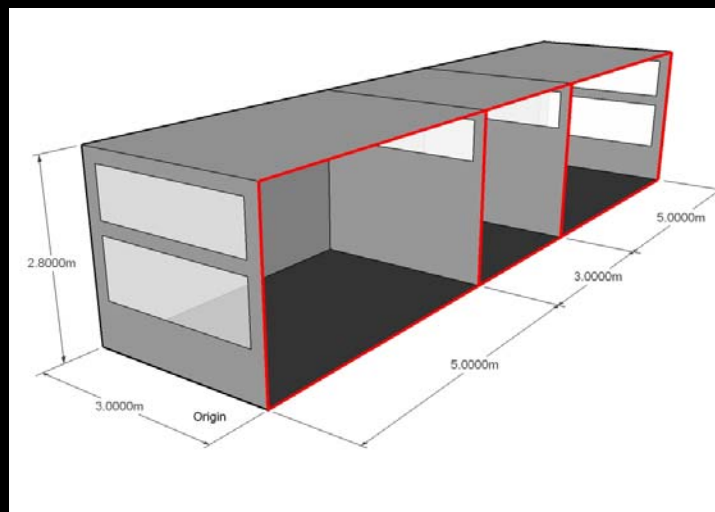

⟨ Located in Ottawa Canada

⟨ Taken from Daysim tutorial

Your Task: Use Daysim to:

- Calculate daylight autonomy and daylight factor in the offices
- Estimate the lighting energy savings from an occupancy sensor.

Short-Time-Step Dynamics of Daylight

Solar Energy

Walkenhorst, Reinhart 2002

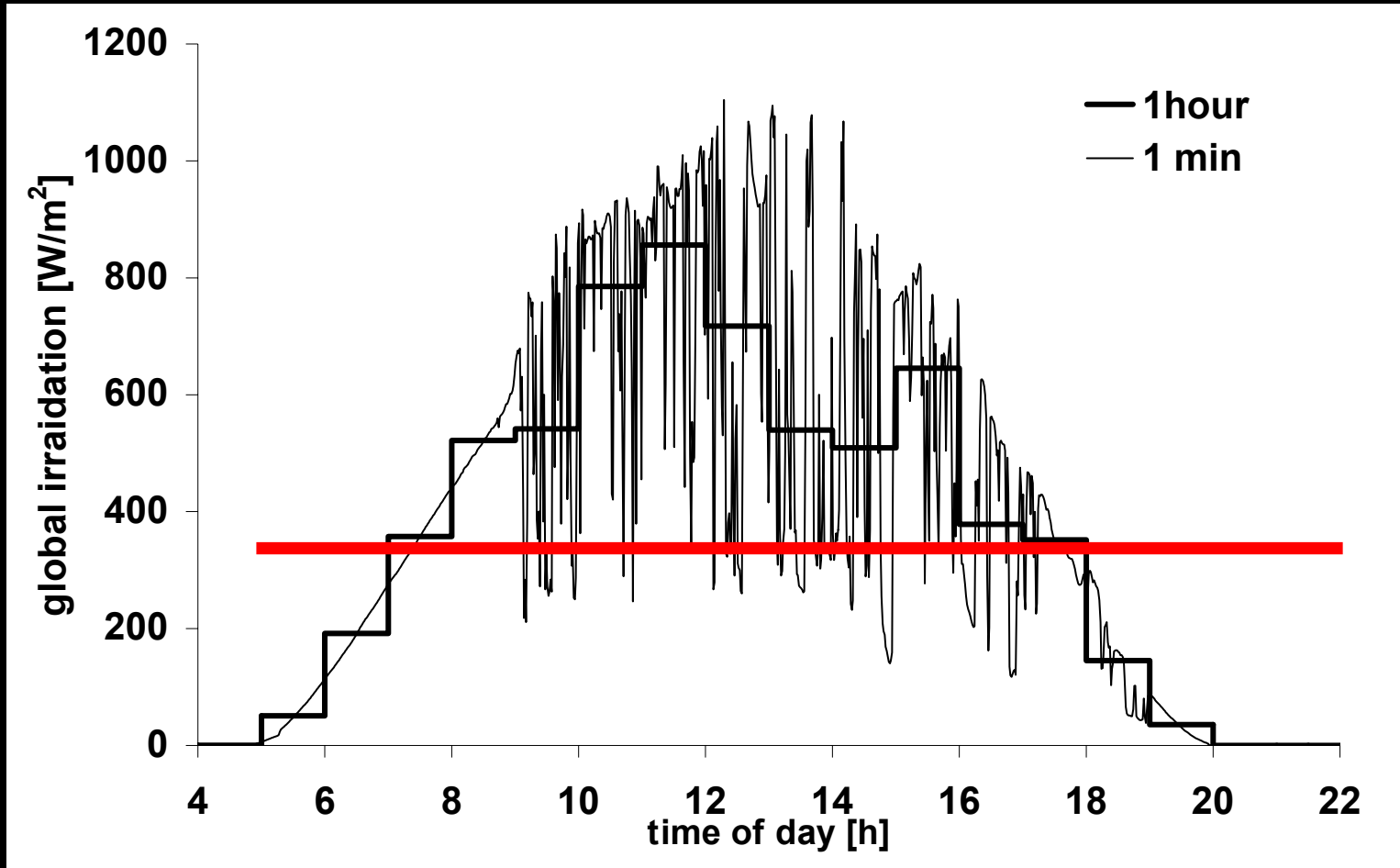

Development of a stochastic Model to calculate 1-min irradiances from 1 hour means

Short-Time-Step Dynamics of Daylight

Step 1: Normalization

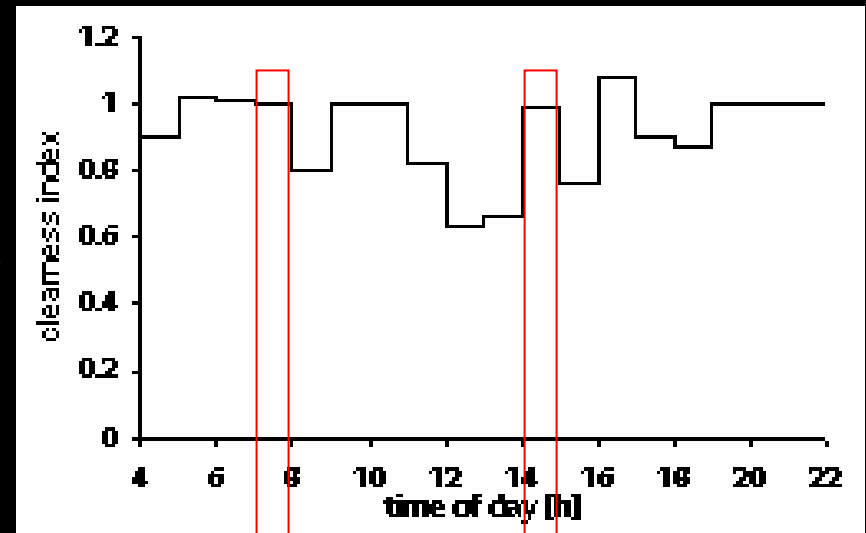
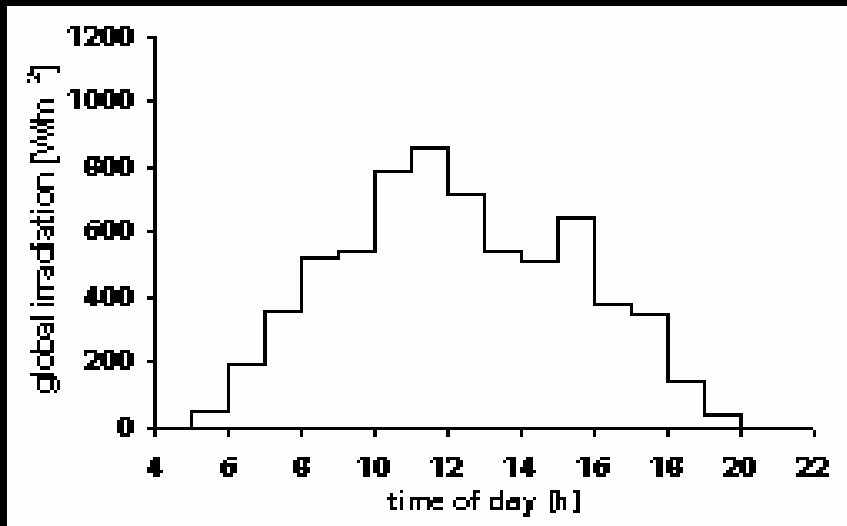

Interval 1

Interval 2

Short-Time-Step Dynamics of Daylight

7AM to 8 AM

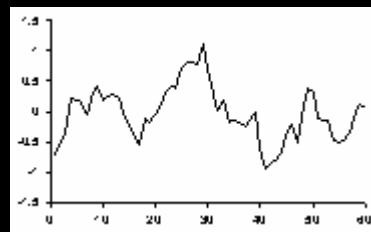
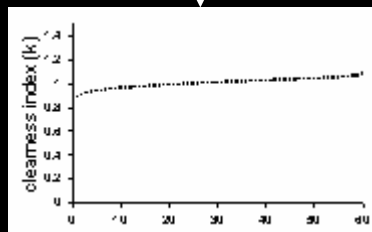

X

2PM to 3PM

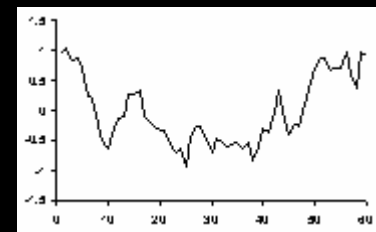
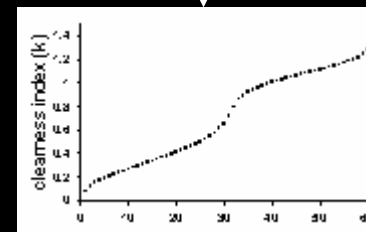

X

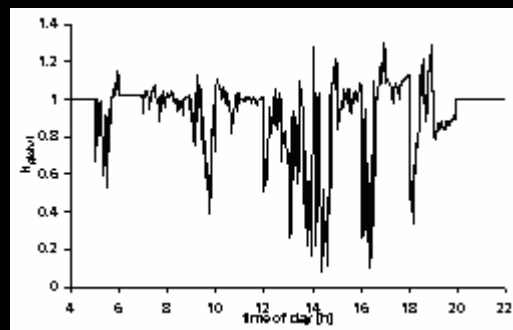
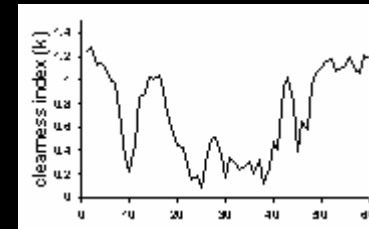
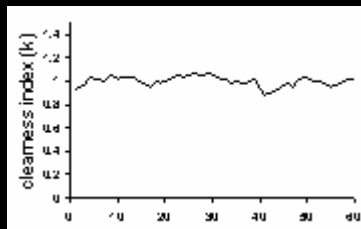

Short-Time-Step Dynamics of Daylight

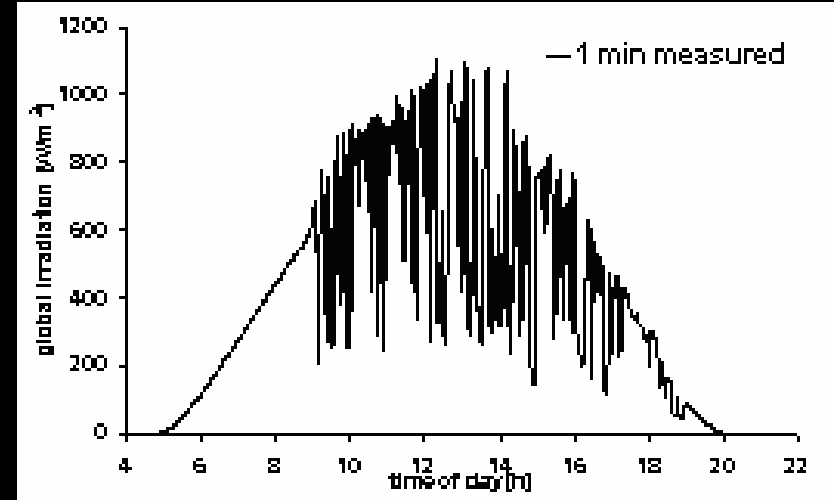
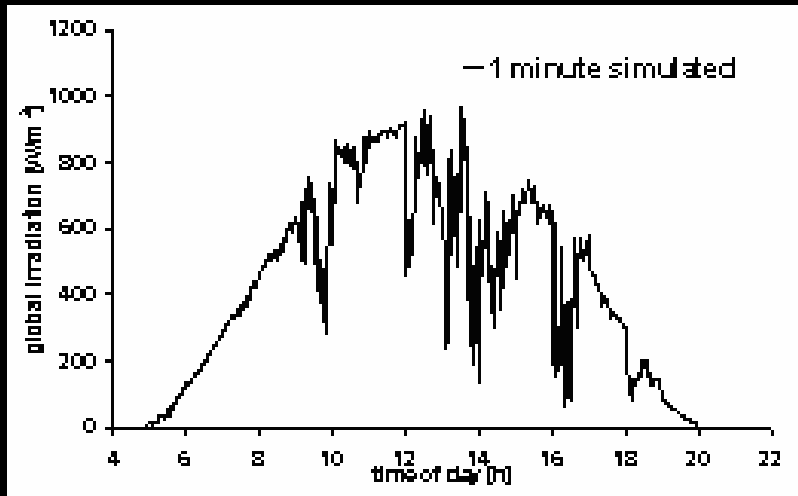

Climate data – US DOE

The screenshot shows a Microsoft Internet Explorer browser window displaying the EnergyPlus Weather Data page. The address bar shows the URL: http://www.eere.energy.gov/buildings/energyplus/cfm/weather_data.cfm. The page header includes the U.S. Department of Energy logo and the text "Energy Efficiency and Renewable Energy" with the tagline "Bringing you a prosperous future where energy is clean, abundant, reliable, and affordable". The main heading is "Building Technologies Program" and the sub-heading is "EnergyPlus Energy Simulation Software". The page content includes a navigation menu, a search bar, and a section titled "Weather Data" which provides information about the availability of weather data for various locations and regions. A sidebar on the left contains a table of contents for the "Weather Data" section.

U.S. Department of Energy
Energy Efficiency and Renewable Energy *Bringing you a prosperous future where energy is clean, abundant, reliable, and affordable*

EERE Home

Building Technologies Program

About the Program | Program Areas | Information Resources | Financial Opportunities | Technologies | Deployment | Home

EnergyPlus Energy Simulation Software

EnergyPlus Home

About EnergyPlus

Getting EnergyPlus

Interfaces & Other Tools

Documentation

Weather Data

- Weather Data Format Definition
- Weather Data Sources
- Real-Time Weather Data

Weather Data

Weather data for more than 900 locations are now available in EnergyPlus weather format — 295 locations in the USA, 55 locations in Canada, and more than 550 locations in 100 other countries throughout the world. The weather data are arranged by World Meteorological Organization region and Country.

- [Africa](#) (WMO Region 1)
- [Asia](#) (WMO Region 2)
- [South America](#) (WMO Region 3)
- [North and Central America](#) (WMO Region 4)
- [Southwest Pacific](#) (WMO Region 5)
- [Europe](#) (WMO Region 6)

 [Get Real-Time Weather Data by Email](#)

http://www.eere.energy.gov/buildings/energyplus/cfm/weather_data.cfm

Dynamic Daylight Simulations (DDS)

- As opposed to **static** DL simulations that only consider one sky condition at a time, **dynamic** daylight simulations generate annual time series of interior illuminances and/or luminances.

How?

Daylight Coefficients

(1) Division of the Celestial Hemisphere

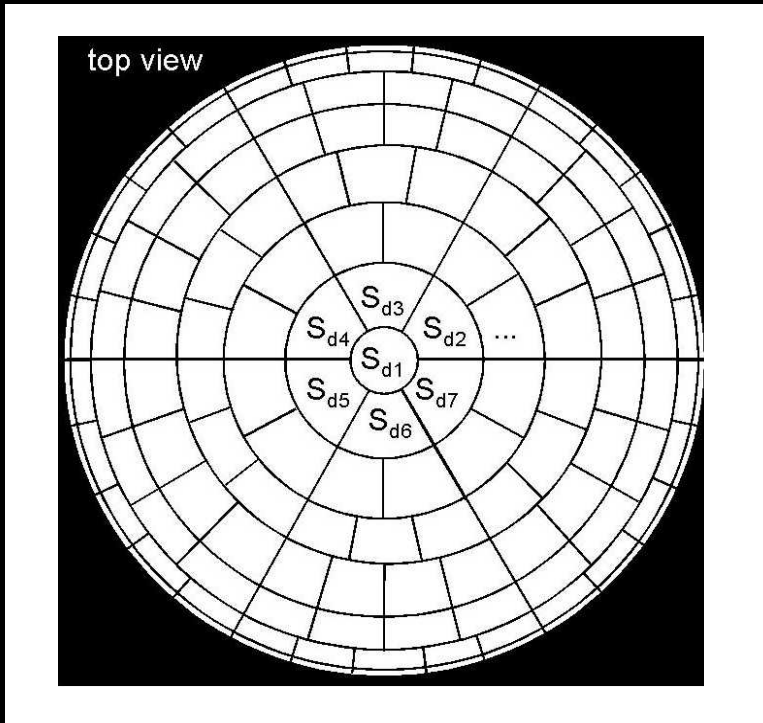

(2) Calculate Daylight Coefficients

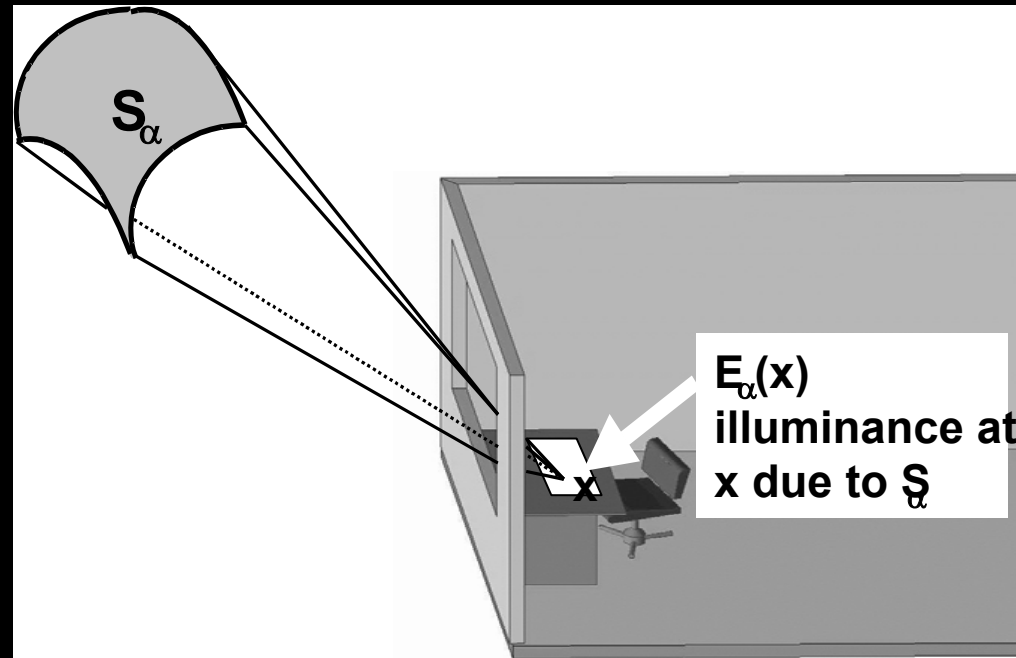

Comparison of Dynamic Daylight Simulation Methods

Energy & Buildings

Reinhart & Herkel 2000

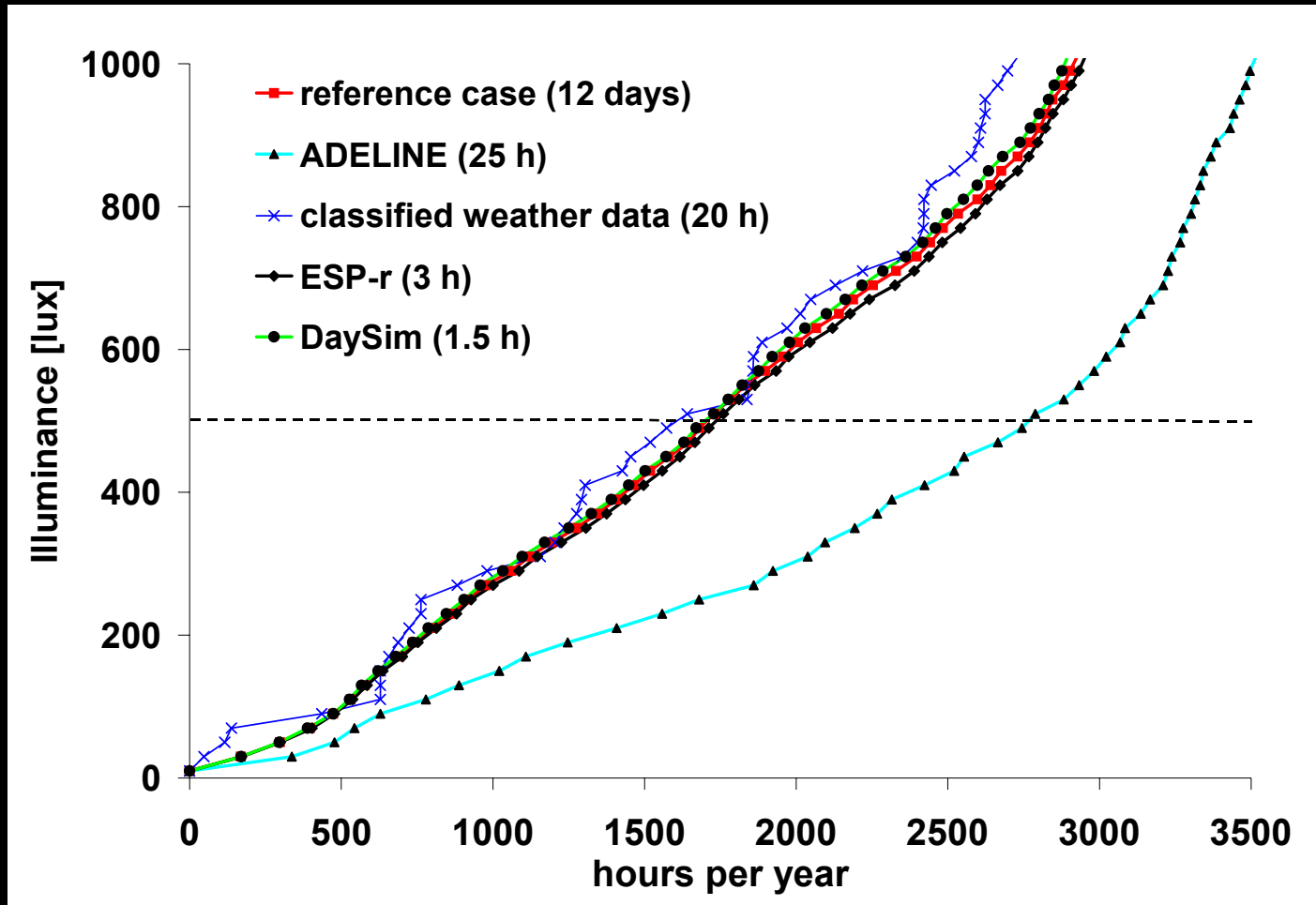

Daylight coefficients: “fastest method & most accurate dynamic method”

Validation II

Light. Res. & Technology
Mardaljevic, 1997

CLEAR GLAZING

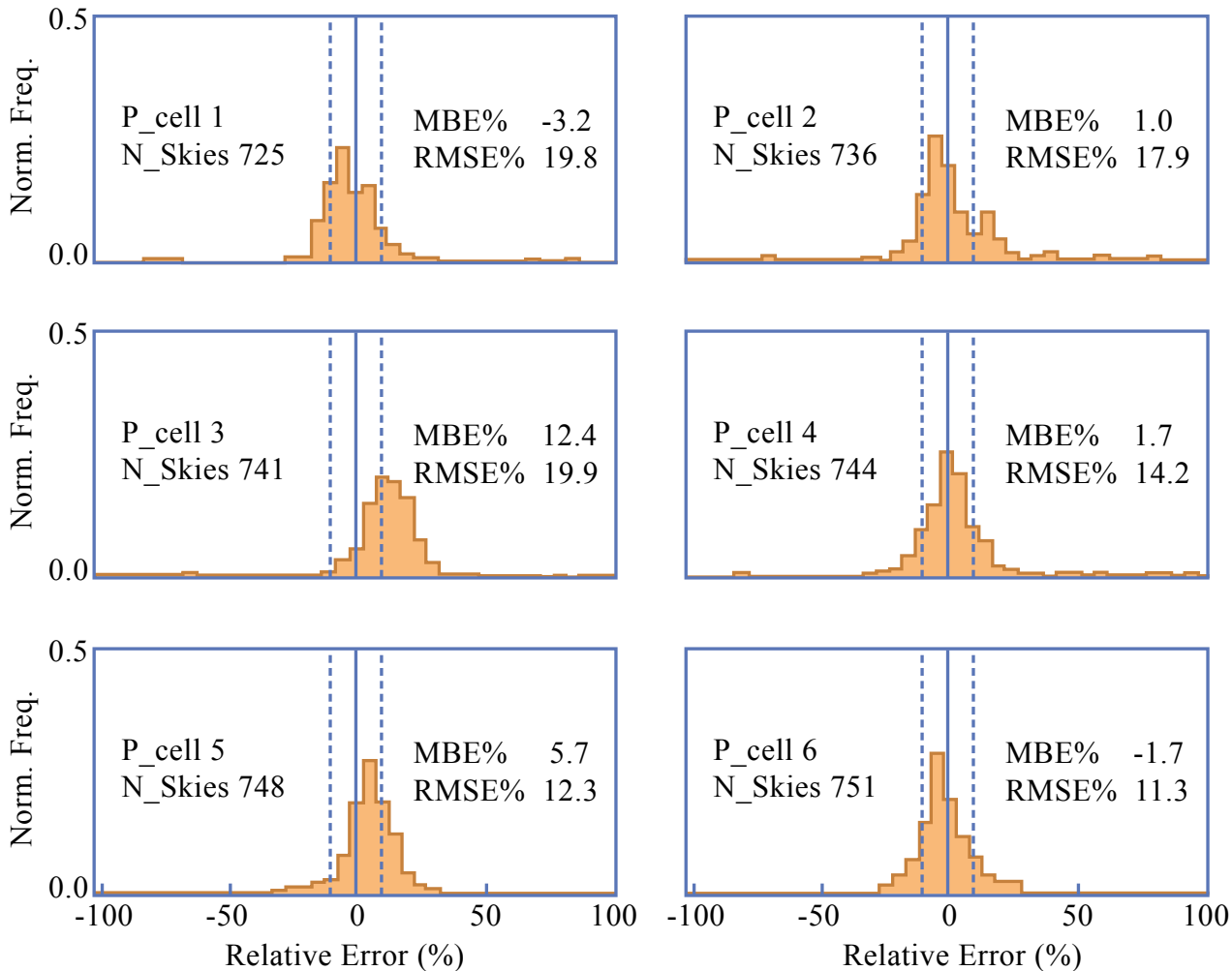
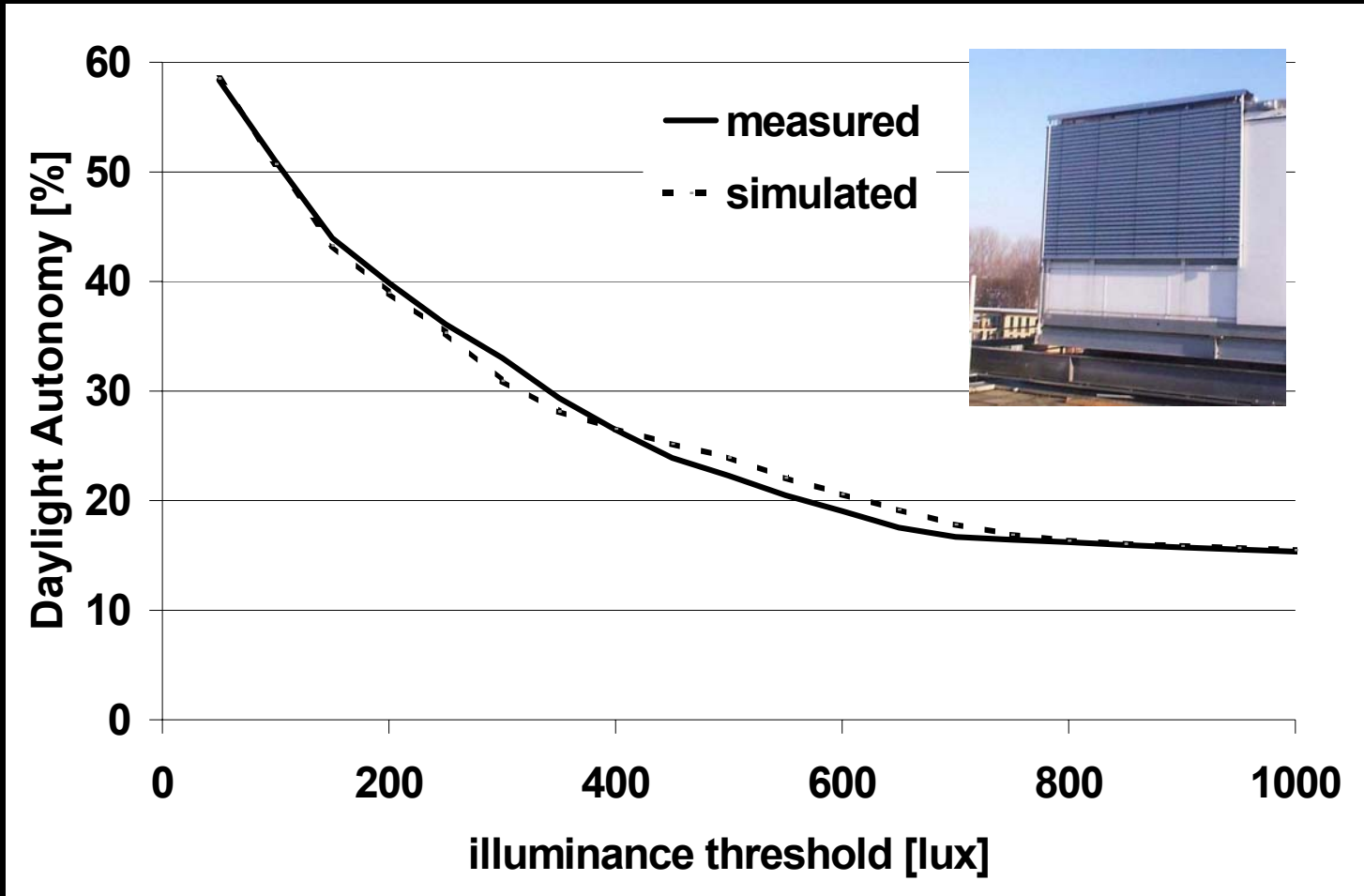

Figure by MIT OCW.

Daylight Coefficients: "same accuracy as standard Radiance"

Validation III - Venetian Blinds

Energy & Buildings
Reinhart, Walkenhorst 2001



RADIANCE-based simulation approach

Validation IV - Translucent Panel



Energy & Buildings Reinhart, Andersen 2005 (in review)

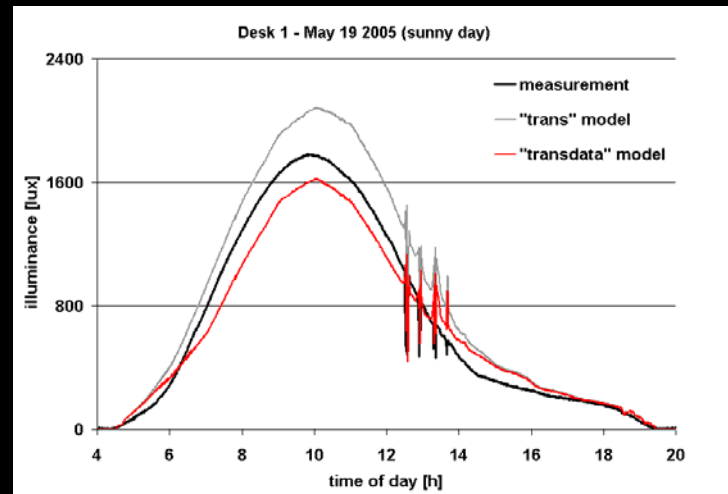
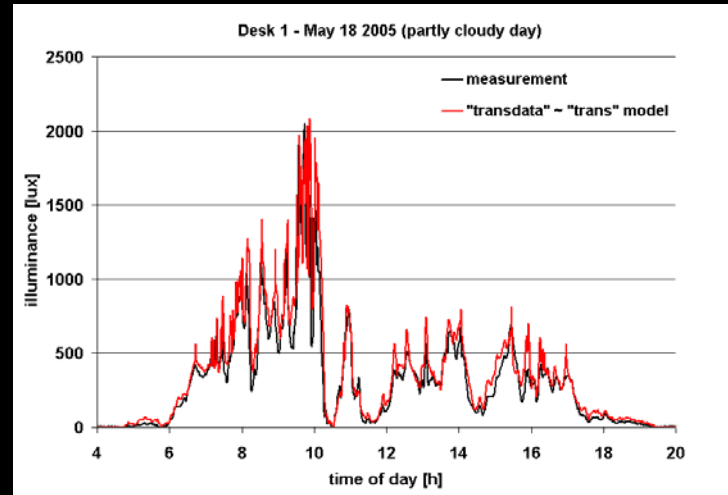

Need for a quality controlled material database.

Summary

- Radiance combined with daylight coefficients and Perez sky model can efficiently and reliably calculate DDS. (validated approach – several independent studies – resulting accuracy ~20% rel. error – comparable to static simulations)

Radiance Simulation Parameters I

ambient bounces	ambient division	ambient sampling	ambient accuracy	ambient resolution	direct threshold	direct sampling
5	1000	20	0.1	300	0	0

$$\text{simulation resolution} = \frac{\text{max scene dimensions x ambient accuracy}}{\text{ambient resolution}}$$

Example:

$$\frac{100\text{m} \times 0.1}{300}$$

~ 3cm (window mullion)

Radiance Simulation Parameters I

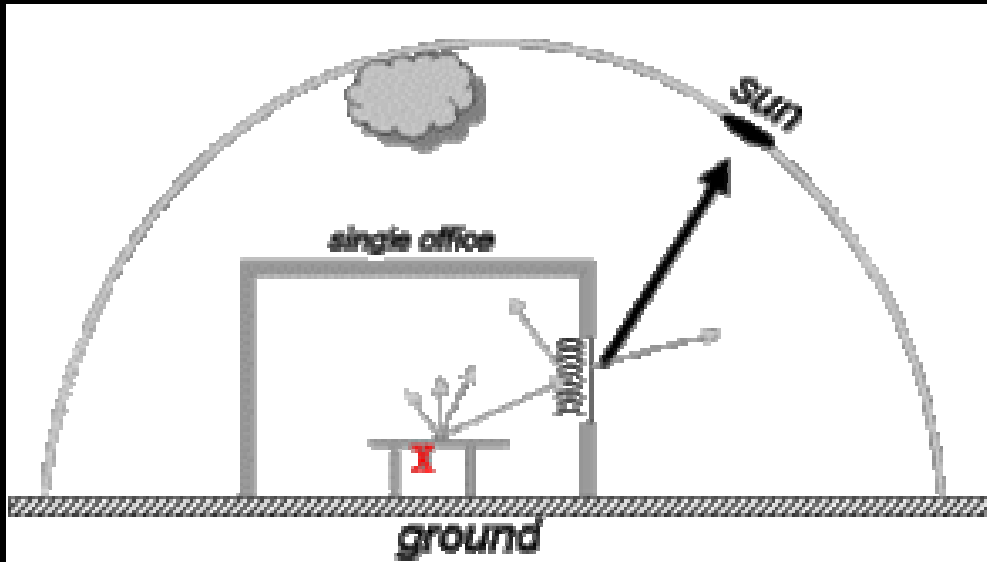

Higher raytracing parameters for blinds

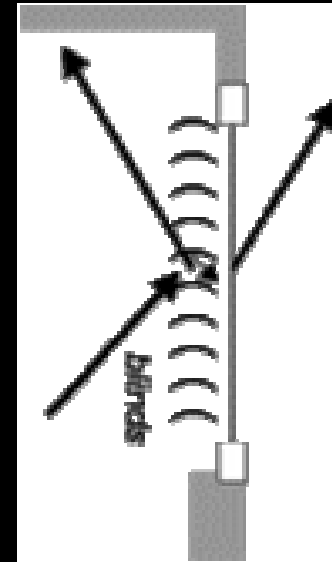

raytracing detail

ambient bounces	ambient division	ambient sampling	ambient accuracy	ambient resolution	direct threshold	direct sampling
7	1500	100	0.1	300	0	0

aa and ar:

$$\frac{\text{maximum scene dimension} \times \text{ambient accuracy}}{\text{ambient resolution}}$$

10m x 0.1 / 300 ~ 0.3cm
(blind slat)

Manual blind control model

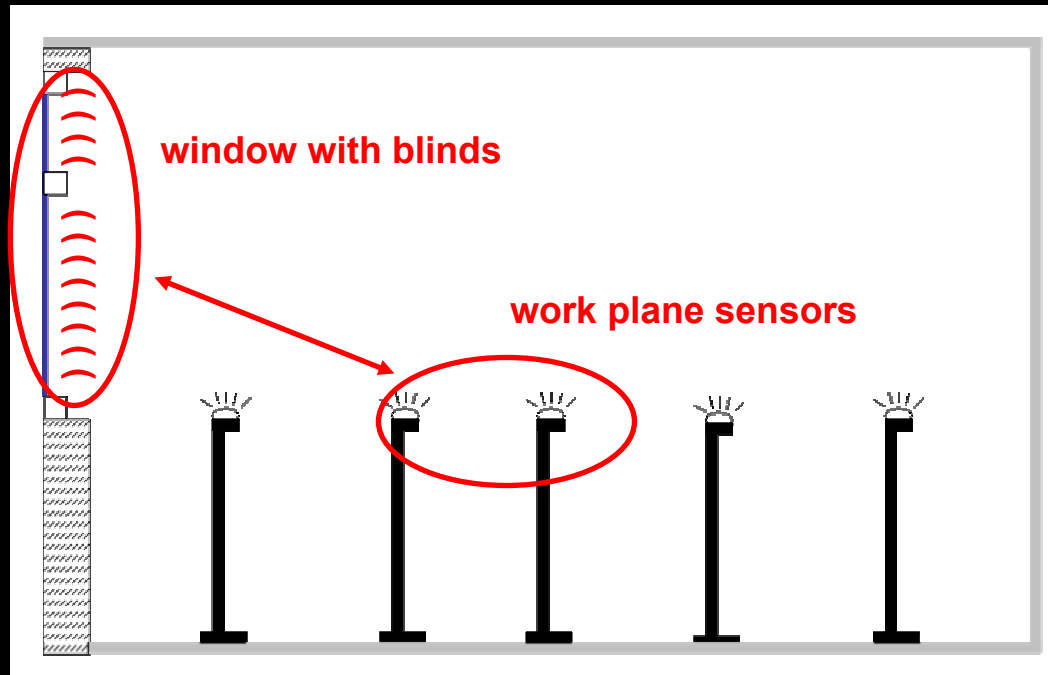

- ⟨ Daysim: active (energy conscious) or passive user
- ⟨ Associate work plan sensor with window
- ⟨ Note: this step requires to couple individual sensors together.
- ⟨ Benefit: Direct comparison between daylighting concepts with and without movable and/or fixed shading devices

Example I – Single office

Daylight factor simulation

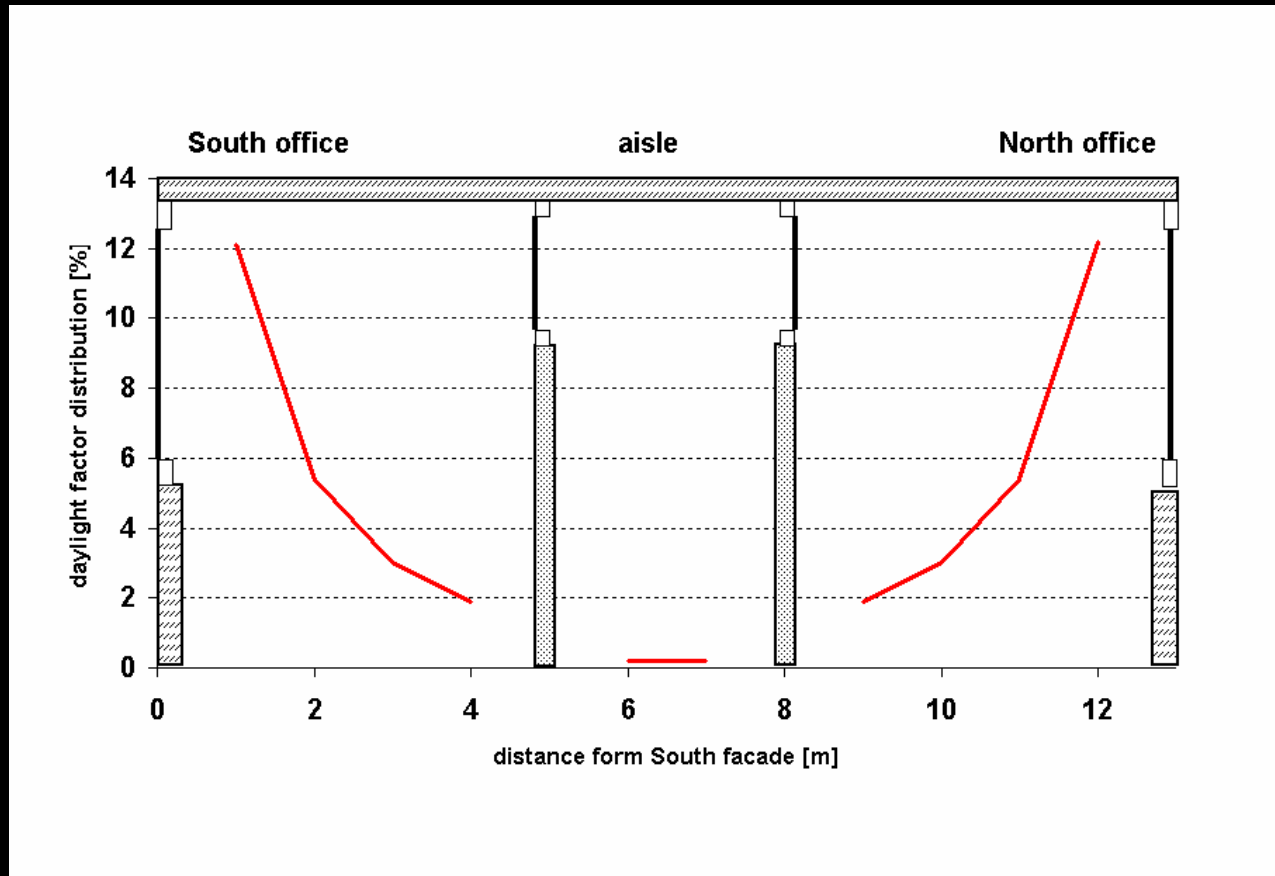

- < same results for North and South offices
- < no daylight on the central aisle

Example I – Single office

Daylight Autonomy simulation

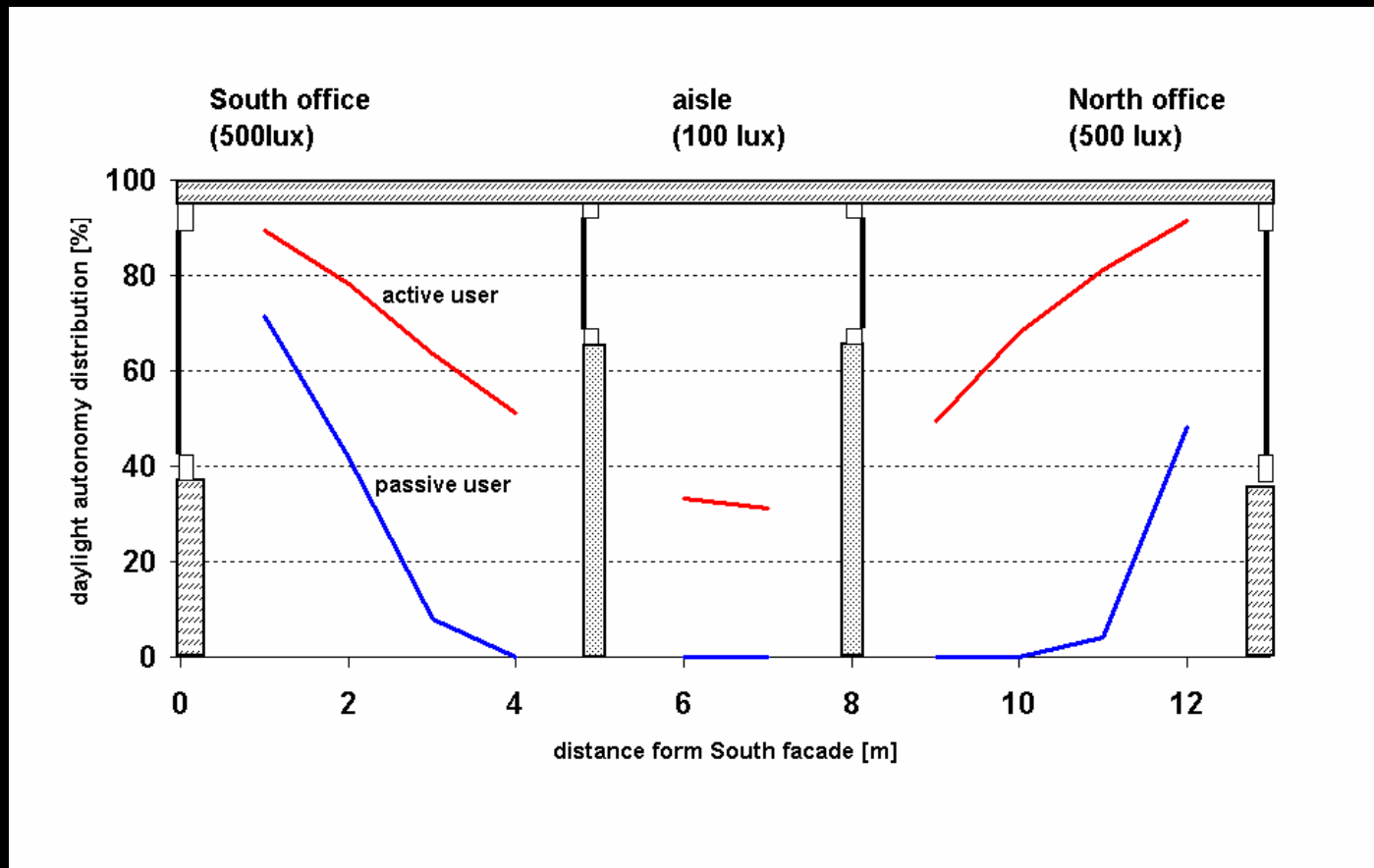

< ample amount of daylight in both offices

< up to 30% DA on aisle => on/off switch with timer

Lighting Controls I

wall mounted

ceiling mounted

■ Occupancy Sensors

- IR: detect changing heat fields (work best when its cool inside)
- UV: detects changing movements (cannot differentiate between a fax machine and a person)
- wall, ceiling mounted, integrated in luminaire
- stand alone, connected to BAS

Lighting Controls II

■ Photocell-controlled Dimming with Occupancy Sensor



Photocell.

Occupancy sensor.

Example I – Single office

Electric Lighting Use in South facing Office

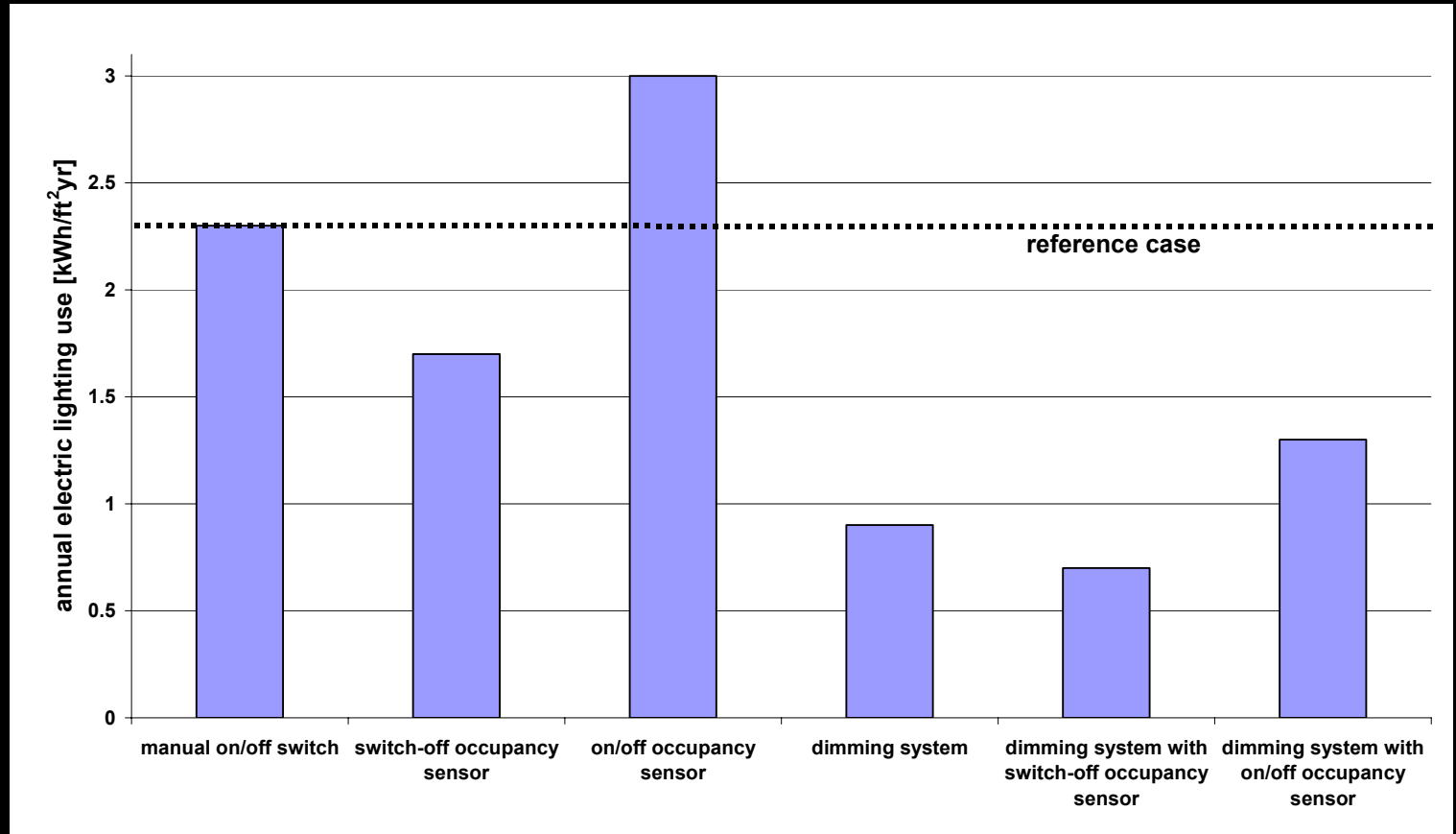

< absolute comparison of different control strategies

< reference case is manual on/off switch with venetian blinds

Example II - Museum Lighting

CIE TC3-22 'Museum lighting and protection against radiation damage'

category	material classification	example of materials	lighting illuminance	limiting annual exposure
I	insensitive	metal, stone, glass, ceramic	no limit	no limit
II	low sensitivity	canvases, frescos, wood, leather	200 lux	600 000 lux h /yr
III	medium sensitivity	watercolor, pastel, various paper	50 lux	150 000 lux h/yr
IV	high sensitivity	silk, newspaper, sensitive pigments	50 lux	15 000 lux h/yr

Example II: Seattle Art Museum - Arup Lighting using Daysim

3D model of site and building

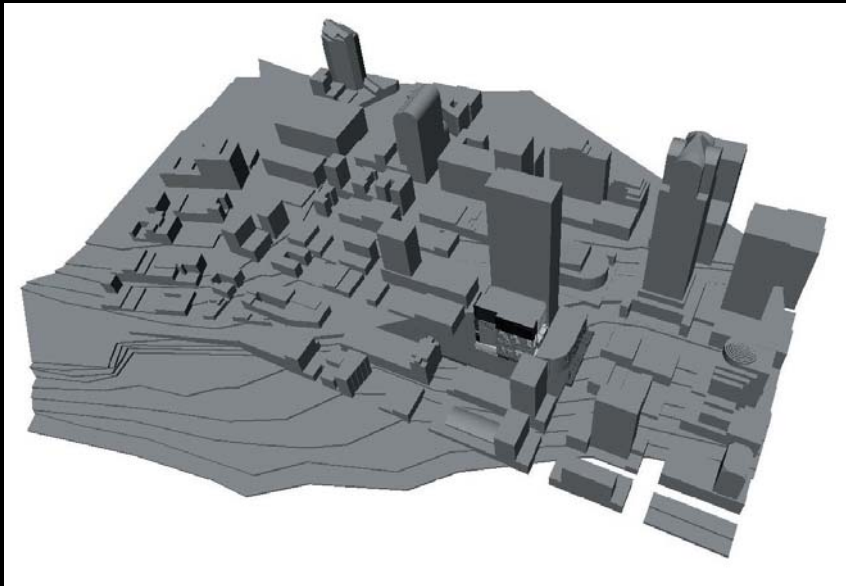

ARUP Lighting

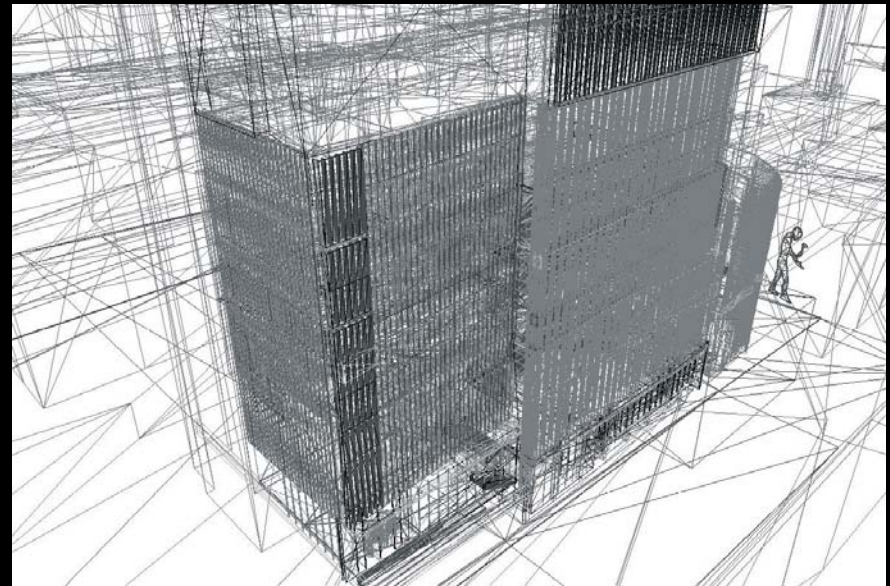

Source: Matt Franks 'Daylighting in Museum's

http://irc.nrc-cnrc.gc.ca/ie/light/RadianceWorkshop2005/PDF/Franks_ArupCaseStudies.pdf

Example II - Seattle Art Museum - Arup Lighting using Daysim

Sidelit Gallery

ARUP Lighting

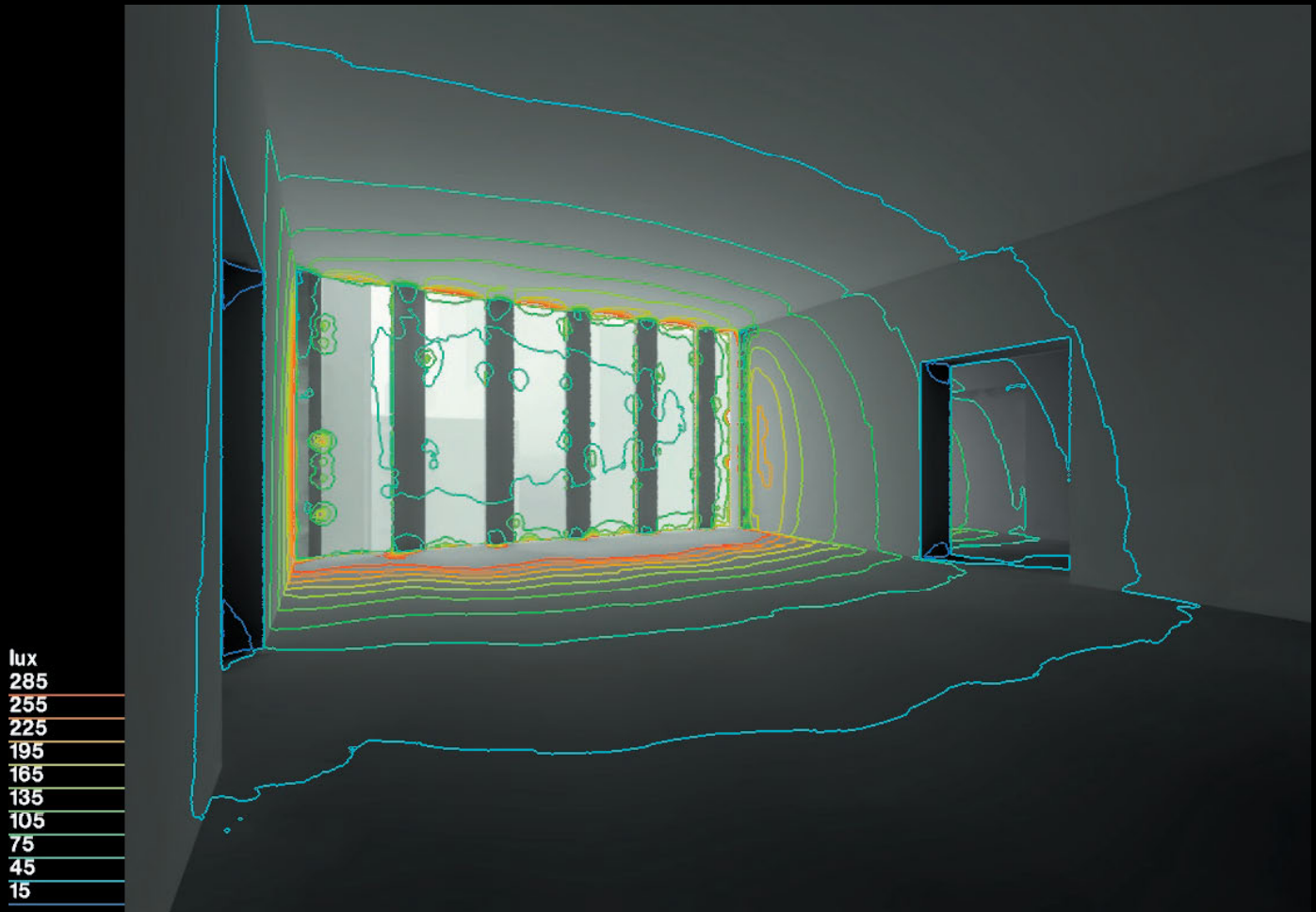

Example II - Seattle Art Museum - Arup Lighting using Daysim

Museum Open Hours - 1,500,000+ lux-hours

ARUP Lighting

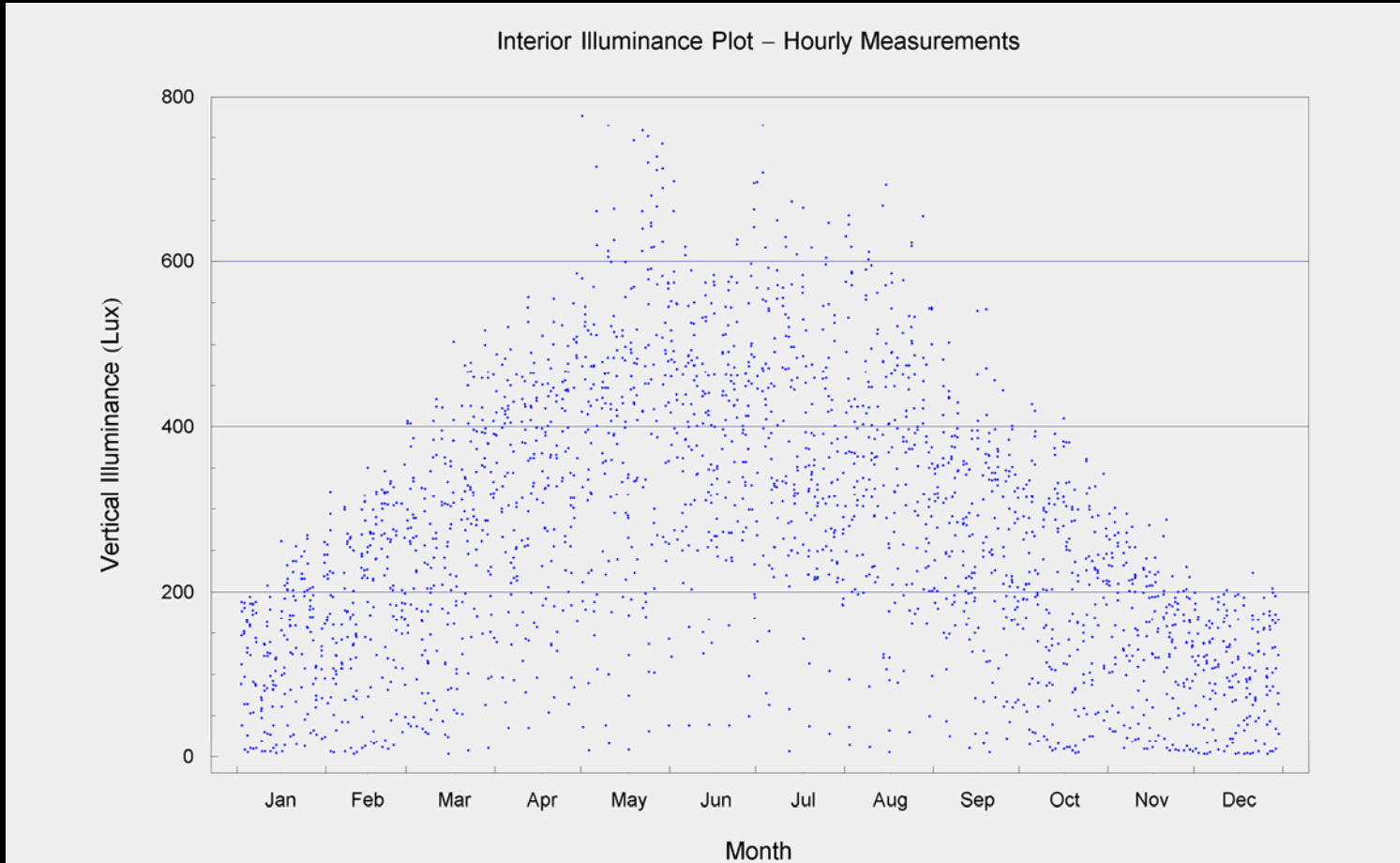

Example II - Seattle Art Museum - Arup Lighting using Daysim

Automatic Shading + Switching - 555,000 lh

ARUP Lighting

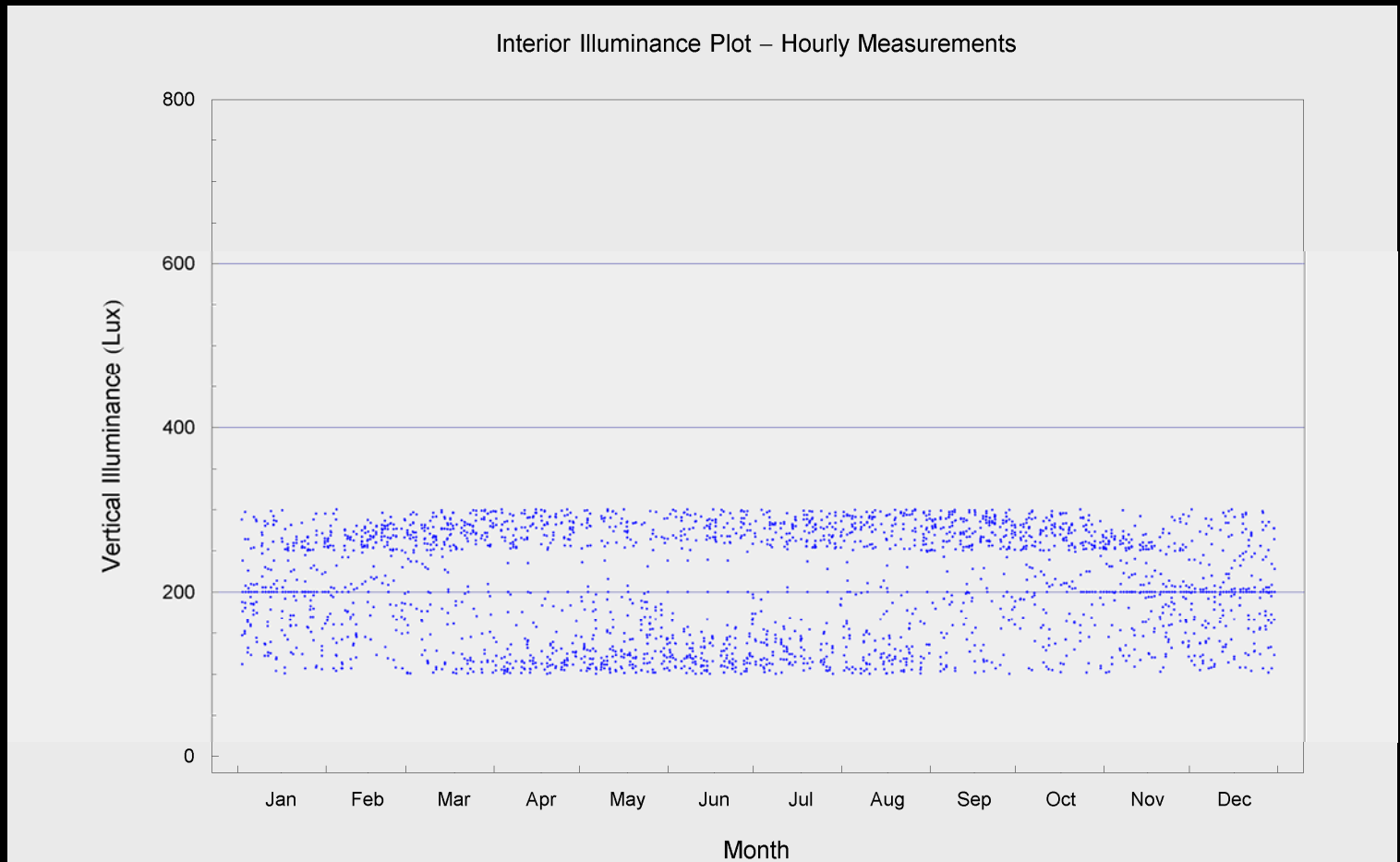

Example III - Classroom

Analysis Grid
Daylight Autonomy
Value Range: 0 - 100 %
© ECOTECT

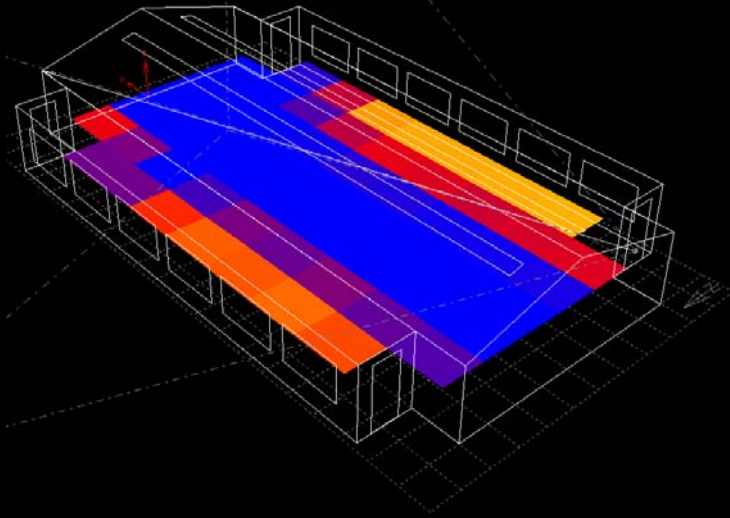

No skylights.

Analysis Grid
Daylight Autonomy
Value Range: 0 - 100 %
© ECOTECT

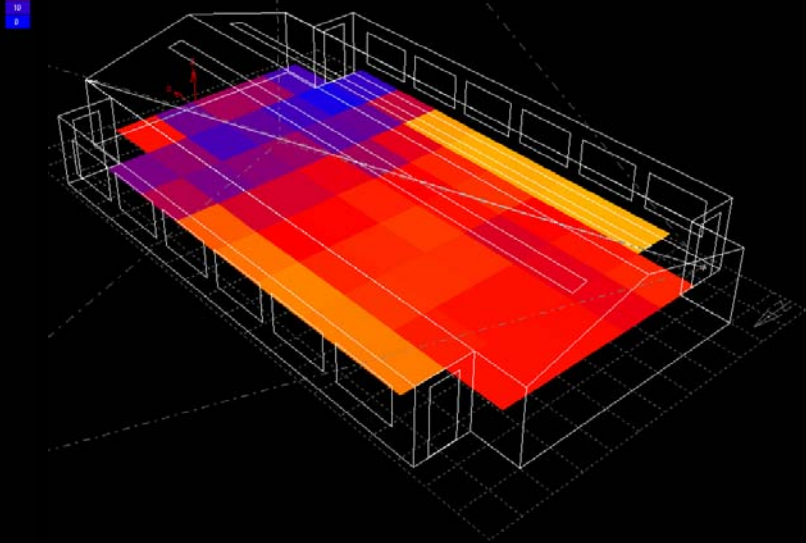

Skylights.